



DIE LINE

CATALOG
VOLUME 2

 **Professional Printers**

803-796-4000
www.proprinters.com

DIELINE 47

Calling Card w/Business Card Slits
Finished Size: 5.5" x 4.25"

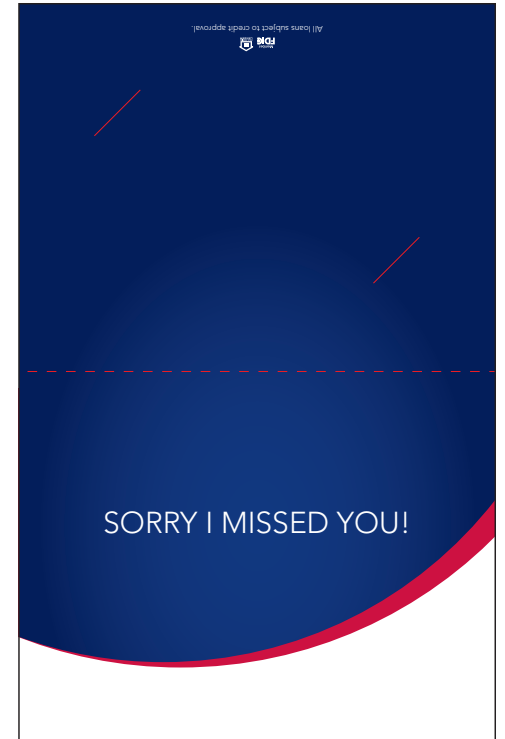
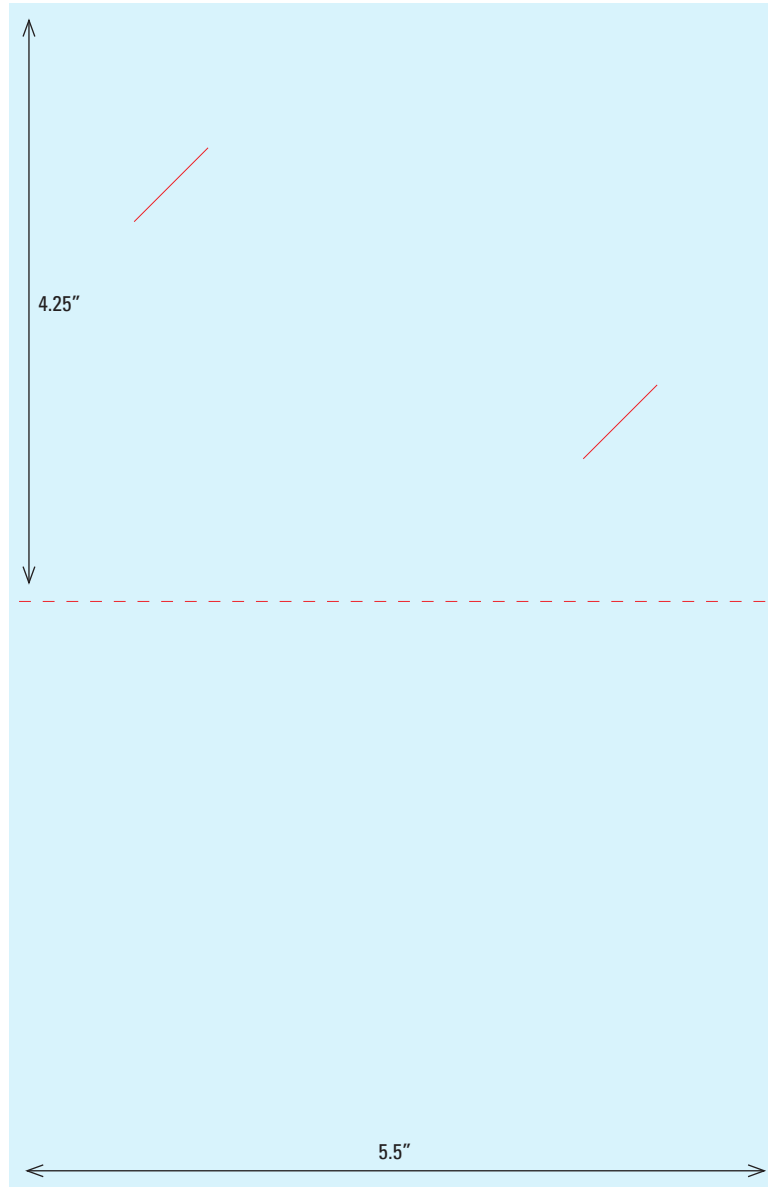

NOT TO SCALE

To order a high res template of a dieline,
please contact your sales representative or
account manager at 803-796-4000.

DIELINE 48

Studio Cards - Diagonal Cut

Finished Size: 2.75" x 2.75"

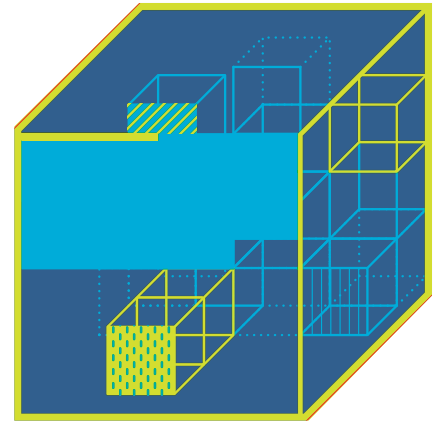
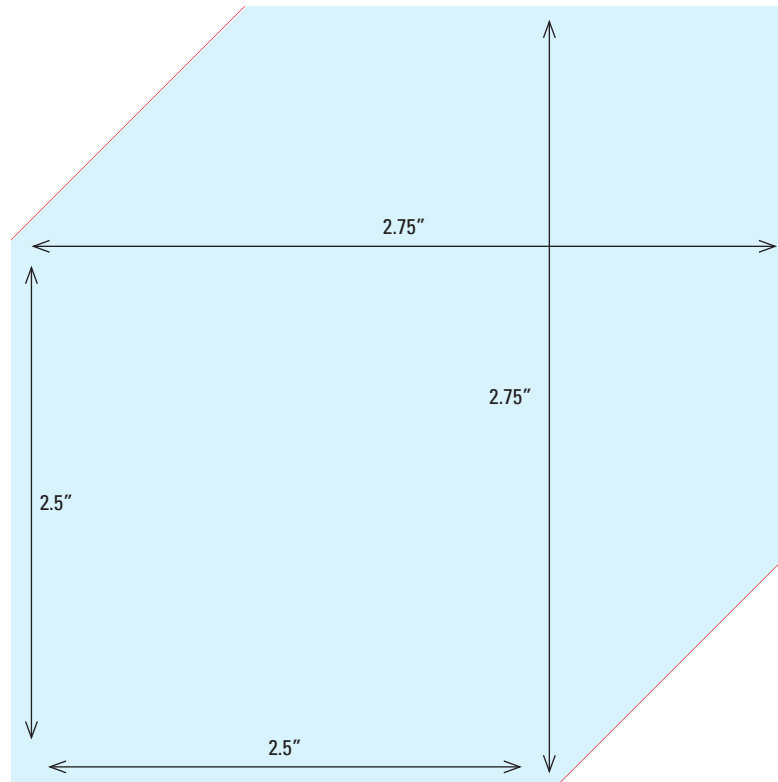

NOT TO SCALE

To order a high res template of a dieline, please contact your sales representative or account manager at 803-796-4000.

DIELINE 49

Mailer

Finished Size: 10" x 4.72"

Note: can remove scores for flat house-shaped piece

Finished Size: 10" x 14"

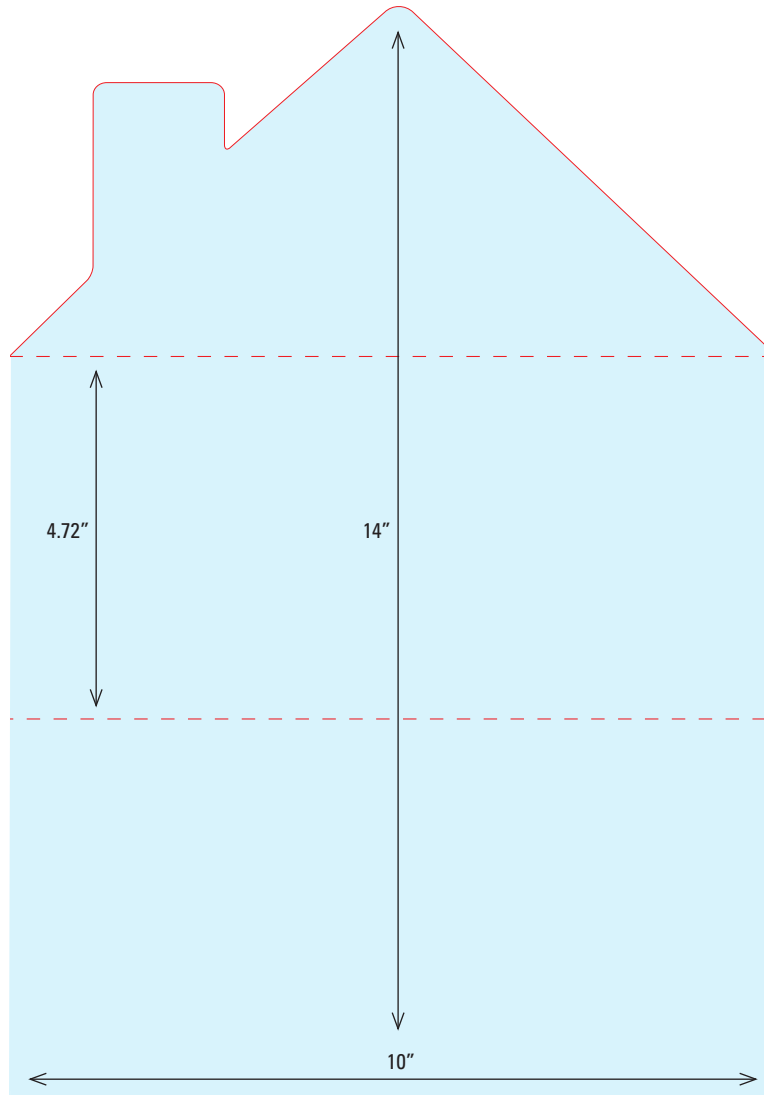

NOT TO SCALE

To order a high res template of a dieline, please contact your sales representative or account manager at 803-796-4000.

DIELINE 50

House

Finished Size: 6.25" x 4.8375"

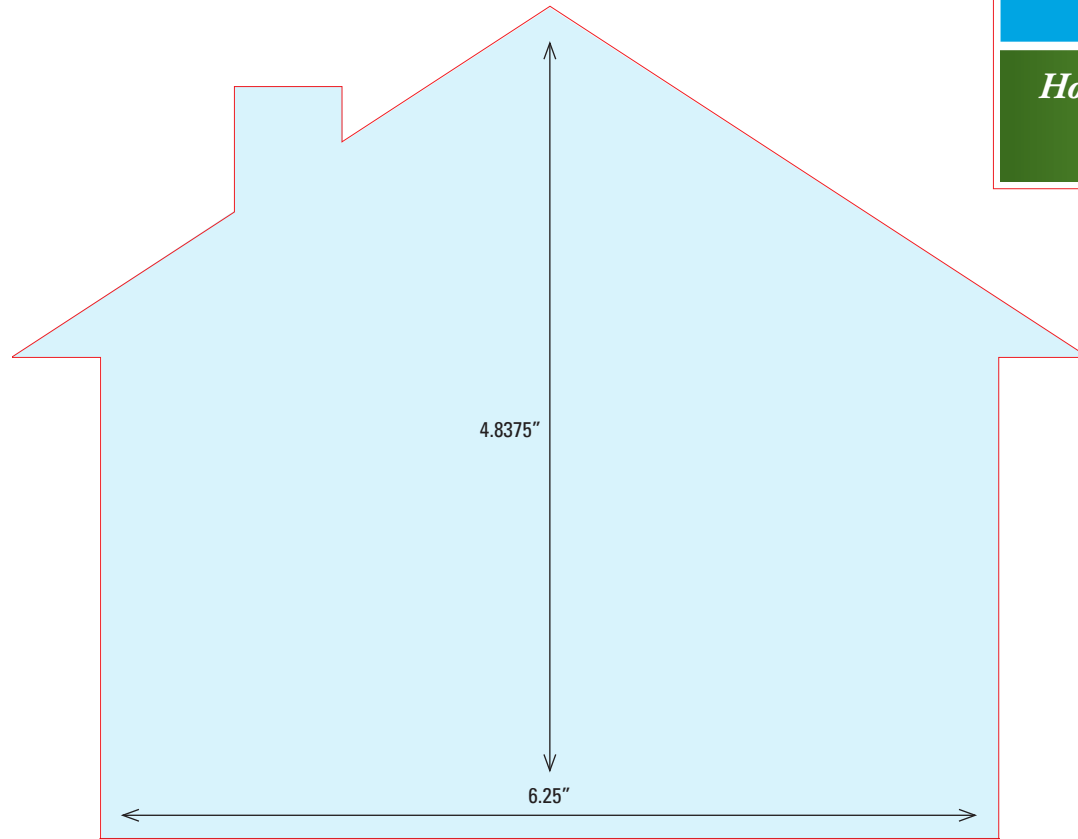

NOT TO SCALE

To order a high res template of a dieline, please contact your sales representative or account manager at 803-796-4000.

DIELINE 51

Mailer w/Perf for Reply
Finished Size: 6" x 4.25"

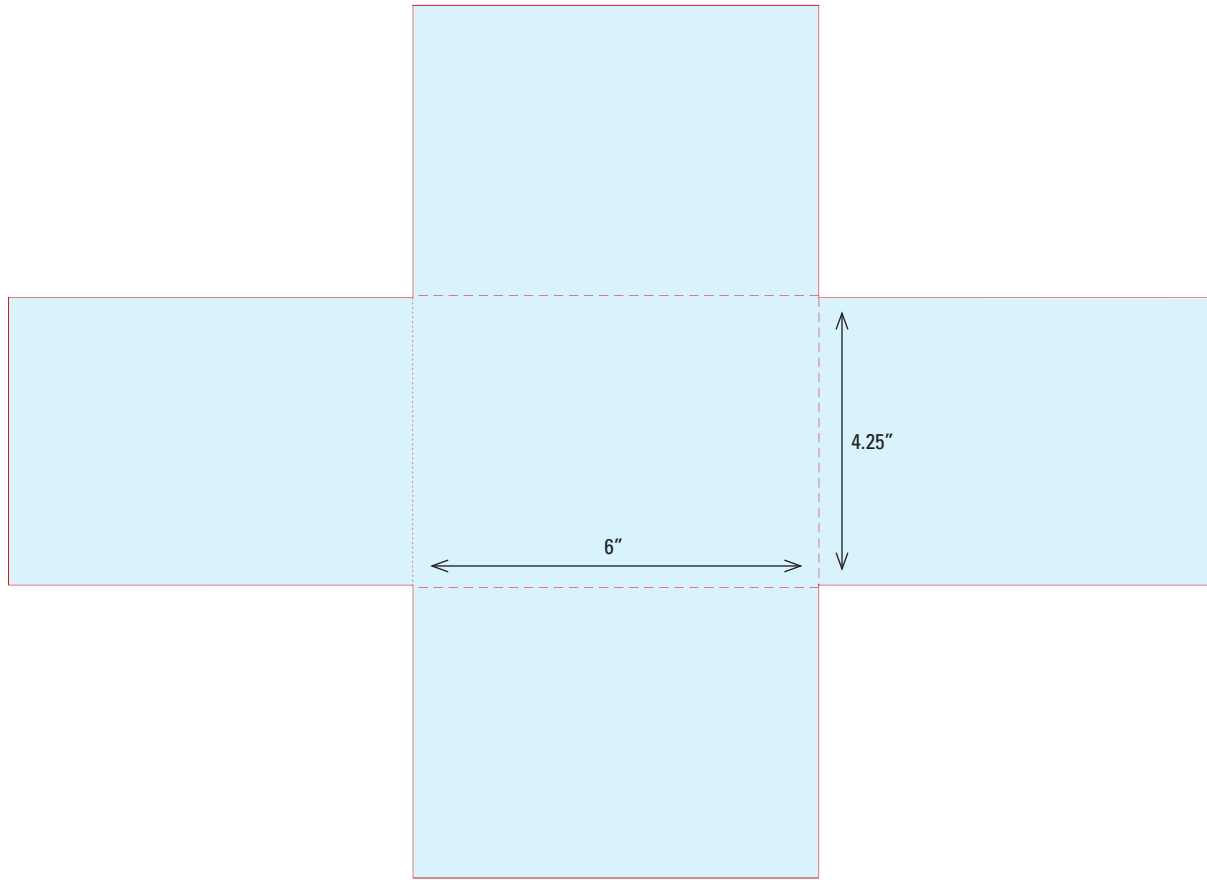

NOT TO SCALE

To order a high res template of a dieline,
please contact your sales representative or
account manager at 803-796-4000.

DIELINE 52

Mailer w/Perf for Reply

Finished Size: 6.125" x 4.3125"

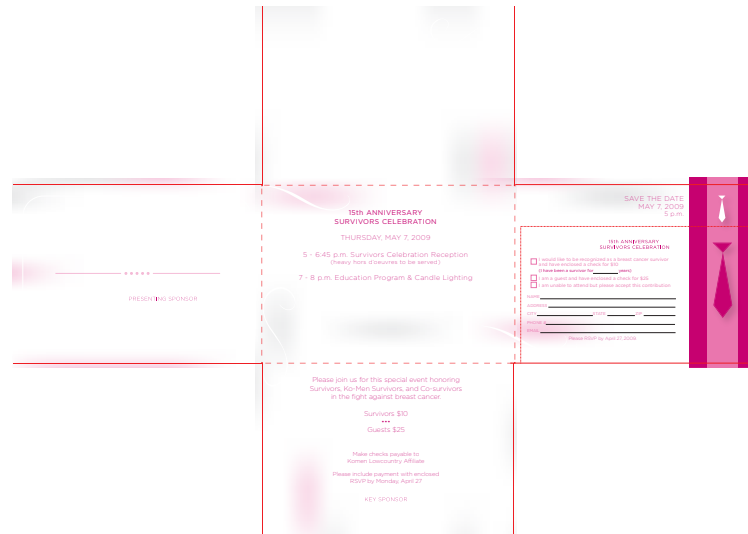
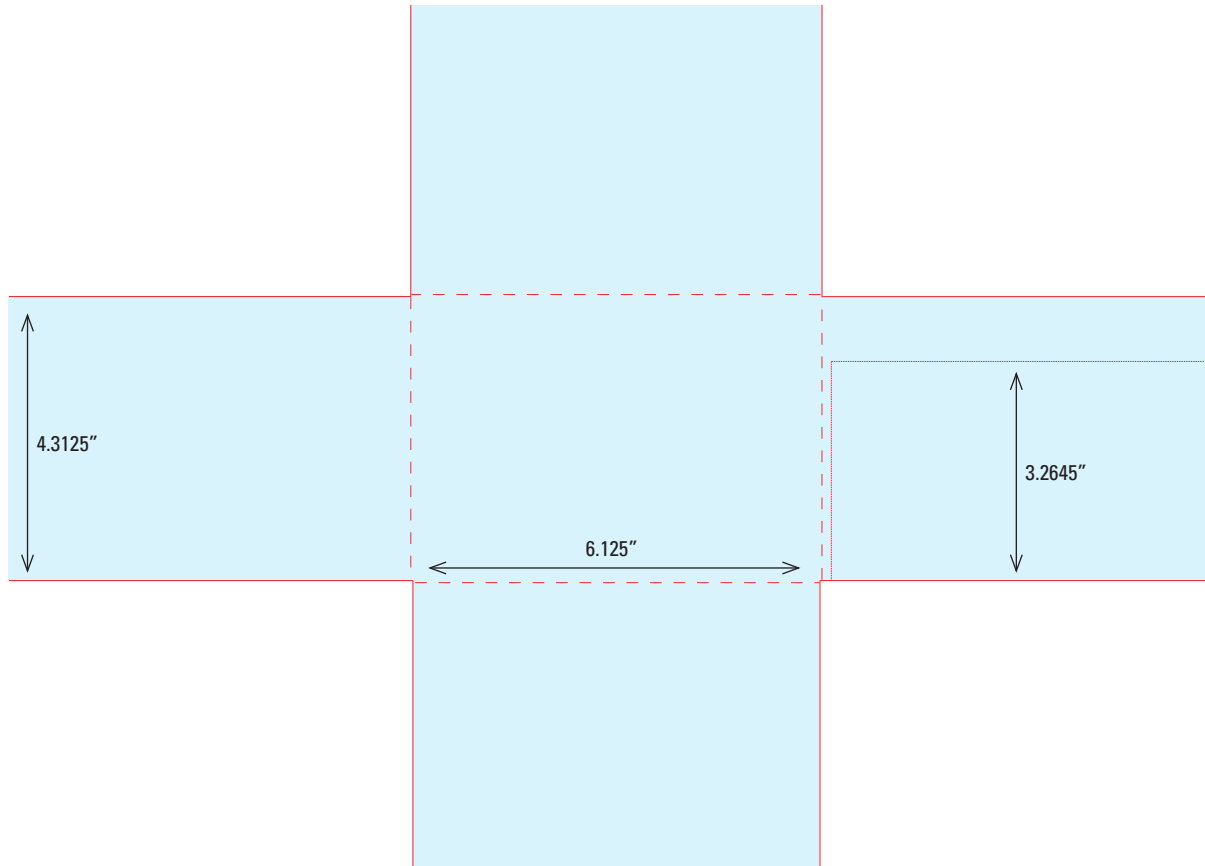

NOT TO SCALE

To order a high res template of a dieline, please contact your sales representative or account manager at 803-796-4000.

DIELINE 53

Pyramid Table Topper

Assembled Size: 5.8831" x 7.0916"

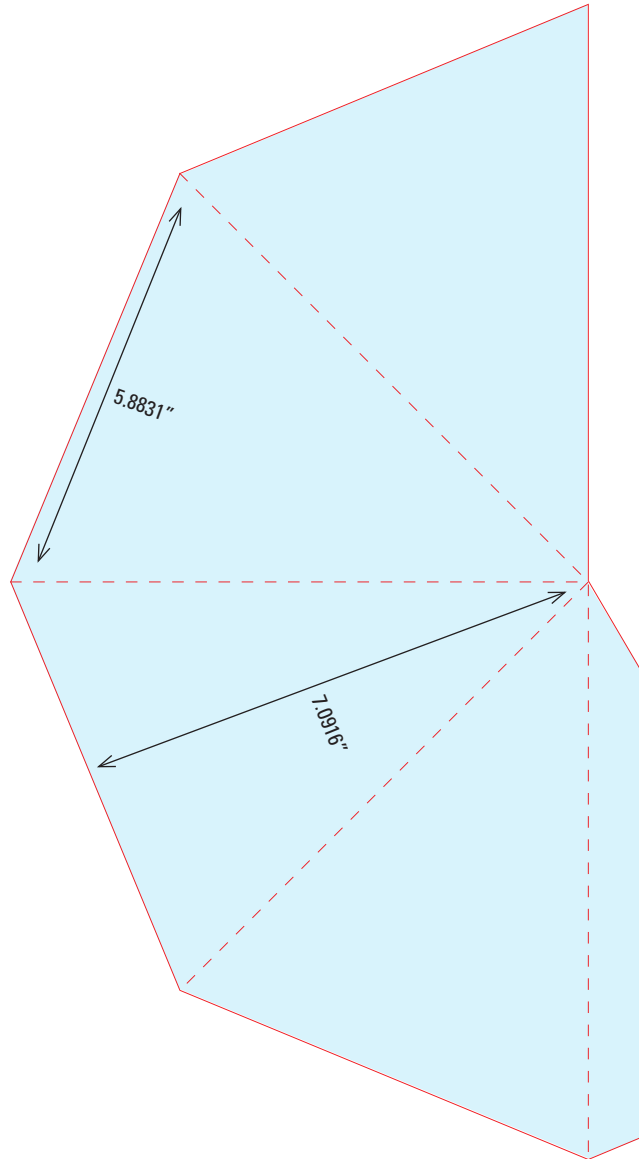

NOT TO SCALE

To order a high res template of a dieline, please contact your sales representative or account manager at 803-796-4000.

DIELINE 54

Brochure, folds to Triangle
Finished Size: 8" x 7"

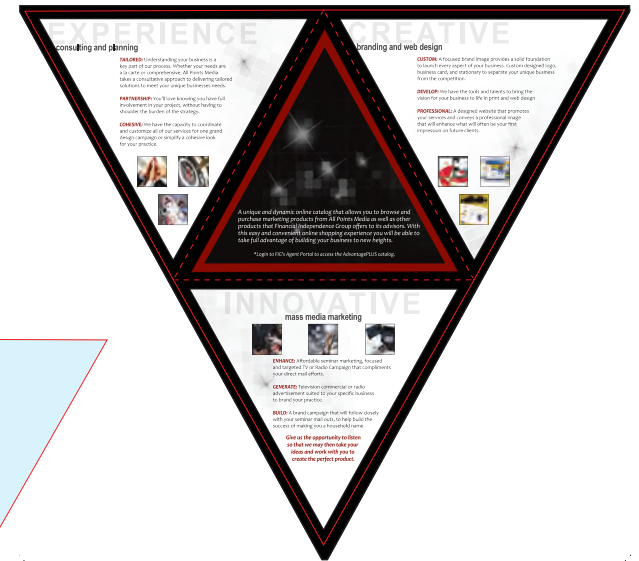
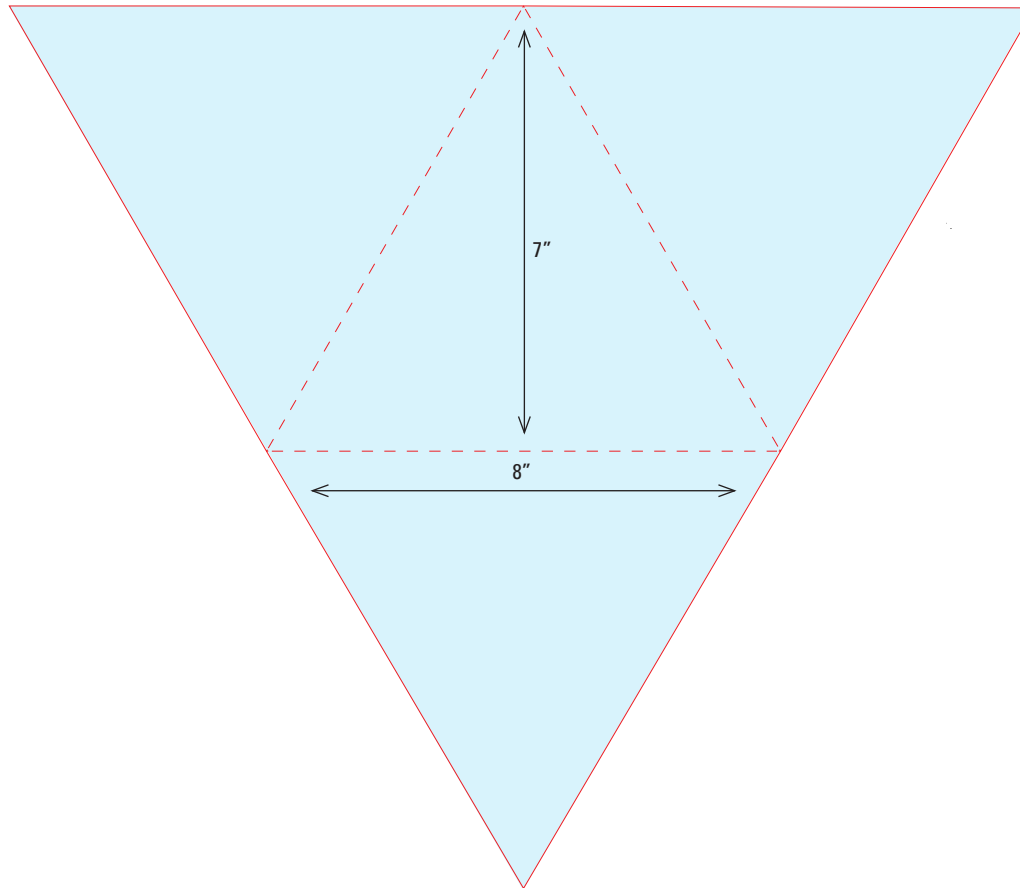

NOT TO SCALE

To order a high res template of a dieline, please contact your sales representative or account manager at 803-796-4000.

DIELINE 55
Notecard
Finished Size: 5" x 7"

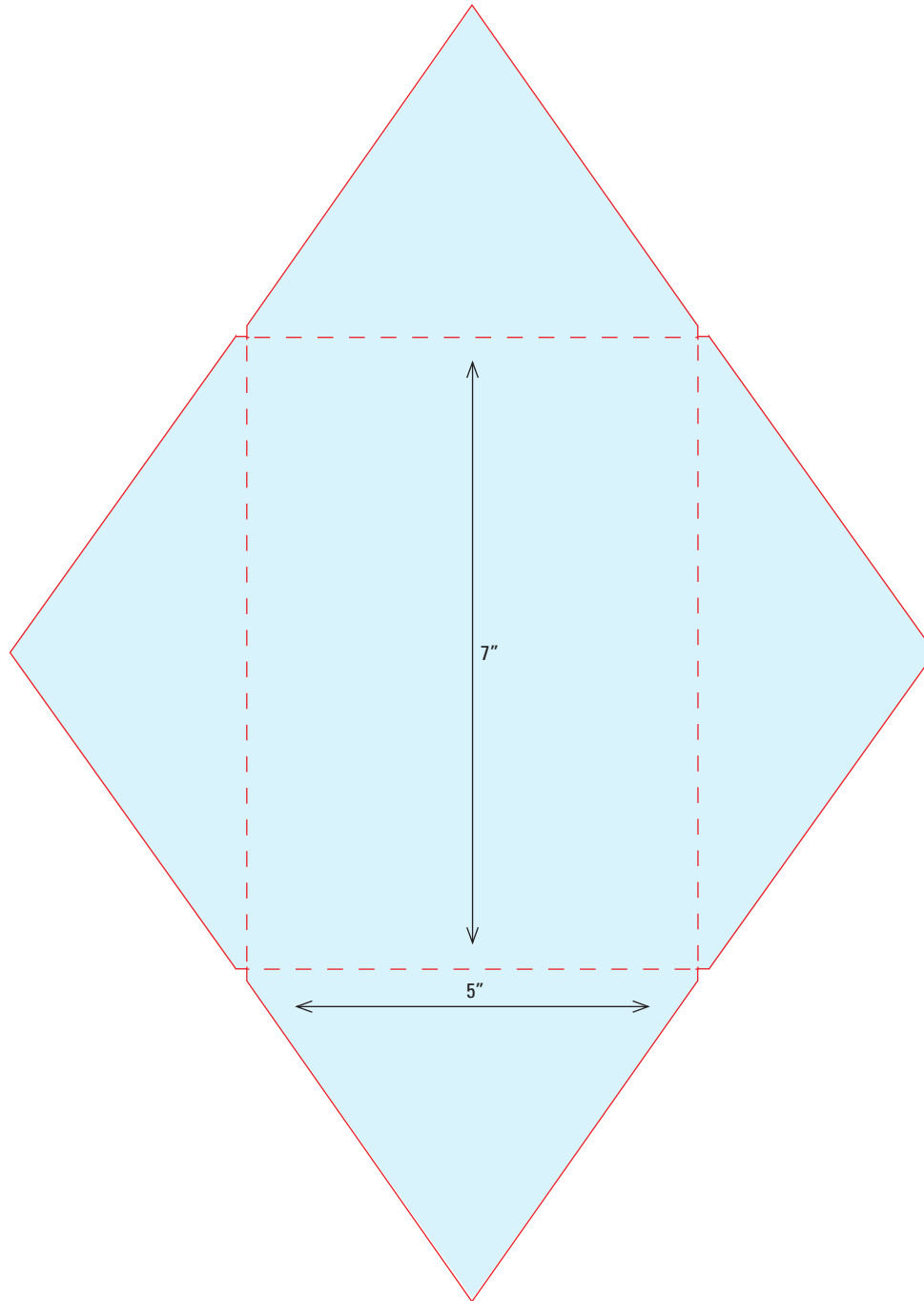

NOT TO SCALE

To order a high res template of a dieline,
please contact your sales representative or
account manager at 803-796-4000.

DIELINE 56

Name Tags

0.125" Round Corners

Finished Size: 2.125" x 3.375"

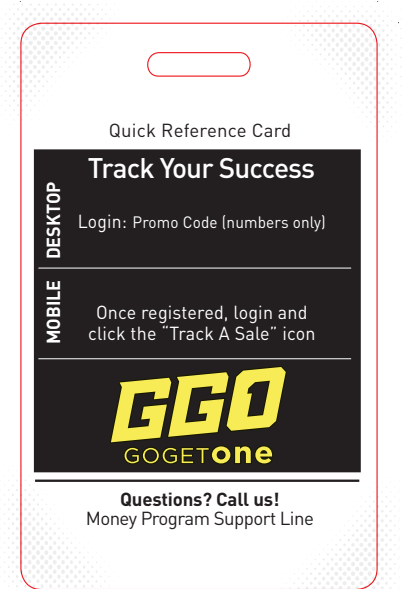
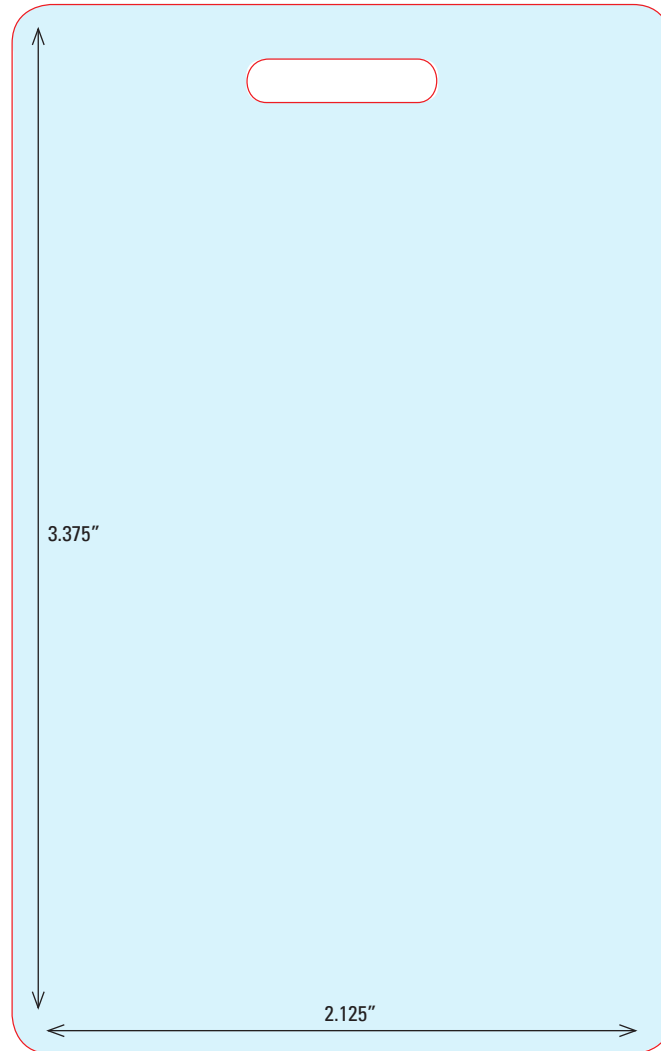

NOT TO SCALE

To order a high res template of a dieline, please contact your sales representative or account manager at 803-796-4000.

DIELINE 57

Booklet Fold Out Cover
Saddle Stitched Booklet
Finished Size: 5.375" x 8.375"

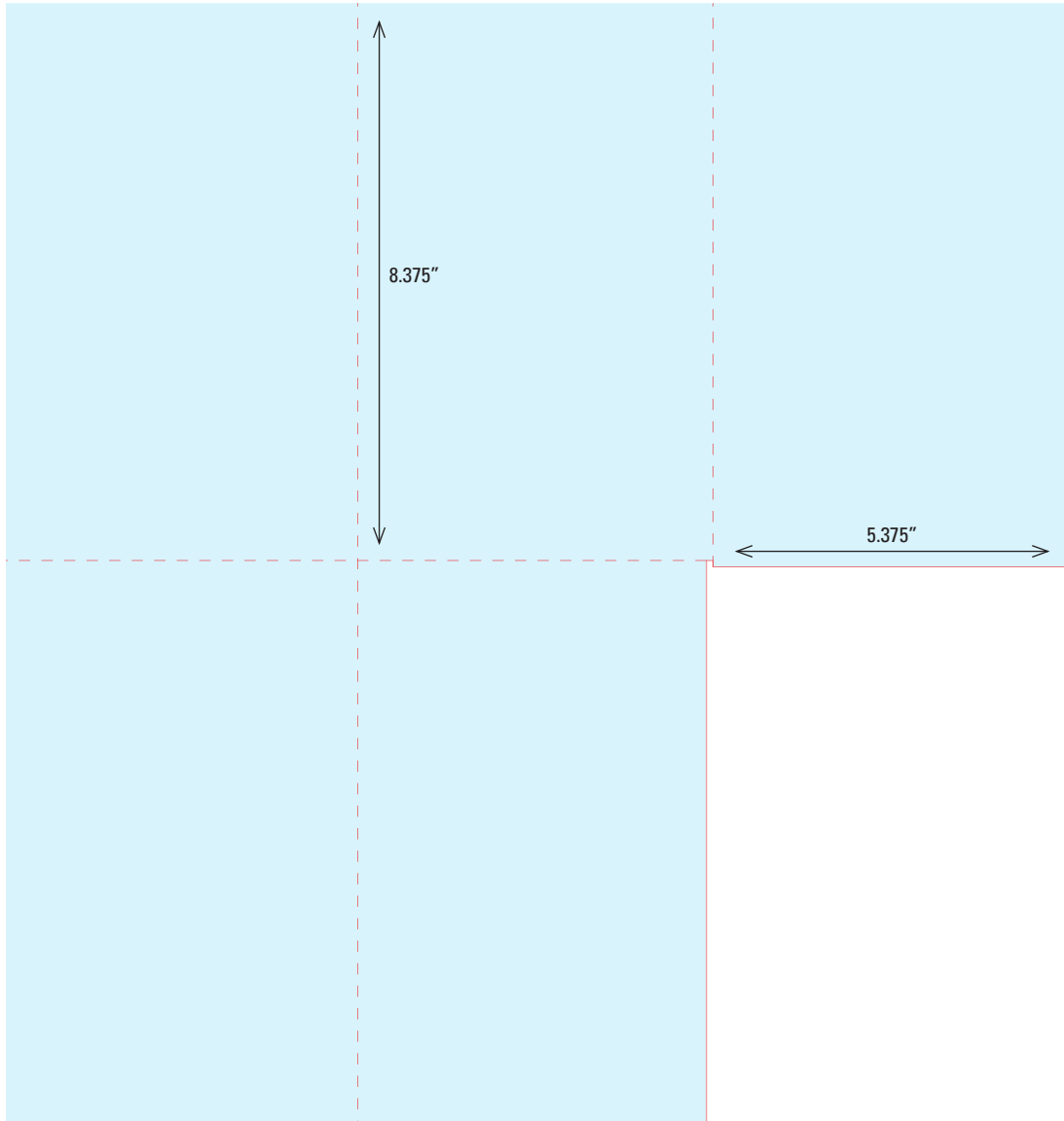

NOT TO SCALE

To order a high res template of a dieline, please contact your sales representative or account manager at 803-796-4000.

DIELINE 58

Ribbon

Finished Size: 6.75" x 10.5"

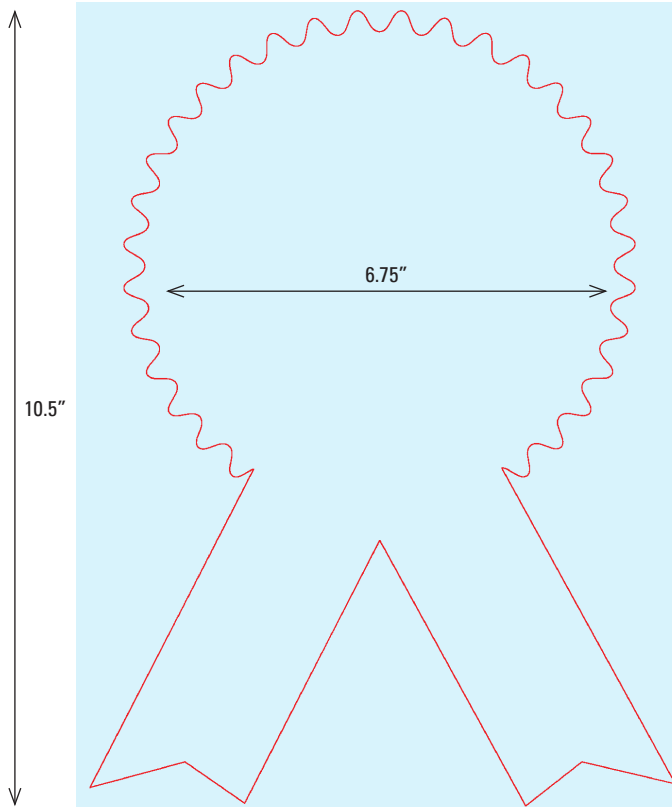

NOT TO SCALE

To order a high res template of a dieline, please contact your sales representative or account manager at 803-796-4000.

DIELINE 59

Tent Card

Flat Size: 8.5" x 14.5"

Assembled Size: 8.5" x 5.5"

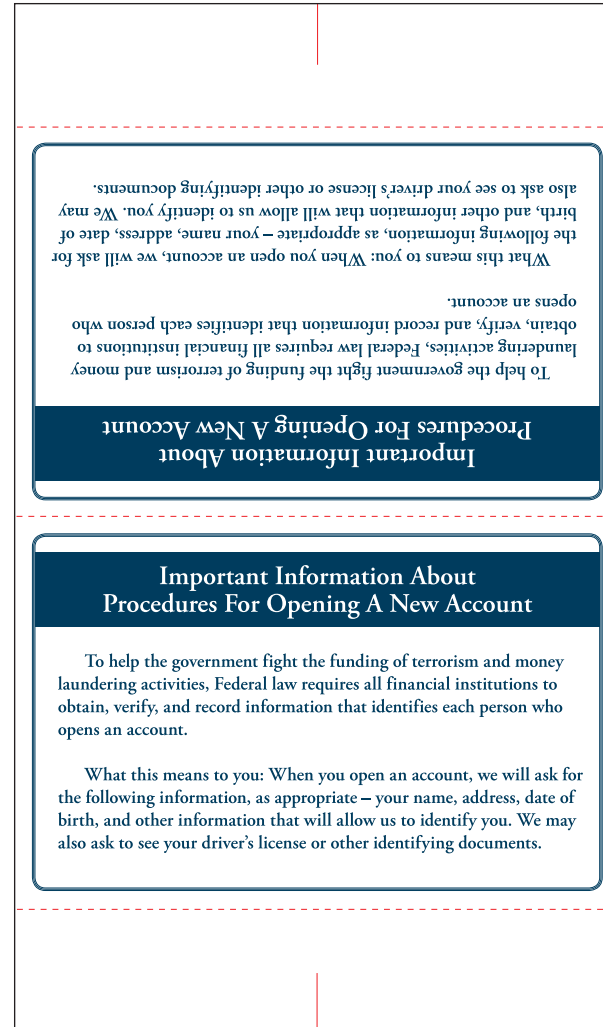
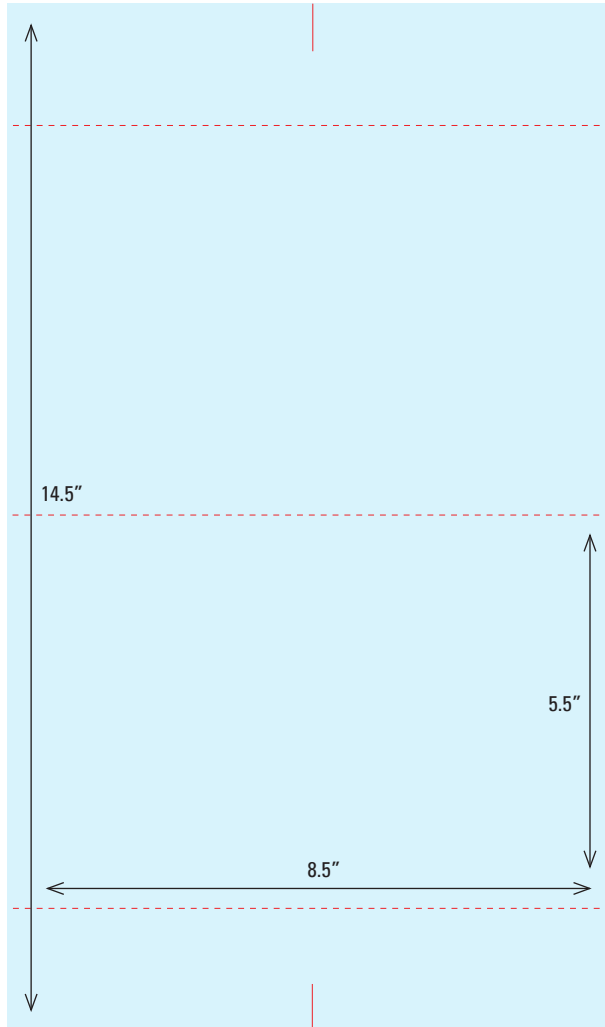

NOT TO SCALE

To order a high res template of a dieline, please contact your sales representative or account manager at 803-796-4000.

DIELINE 60

Deck of Cards Box

Assembled Size: 3.1" x 4.377"

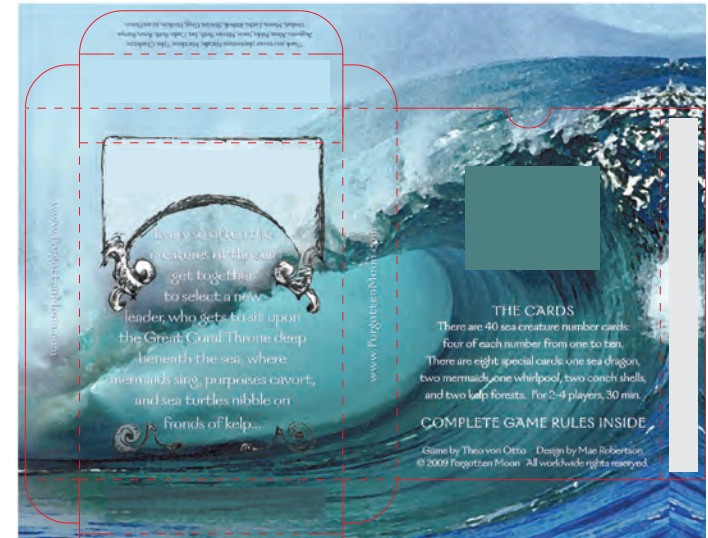
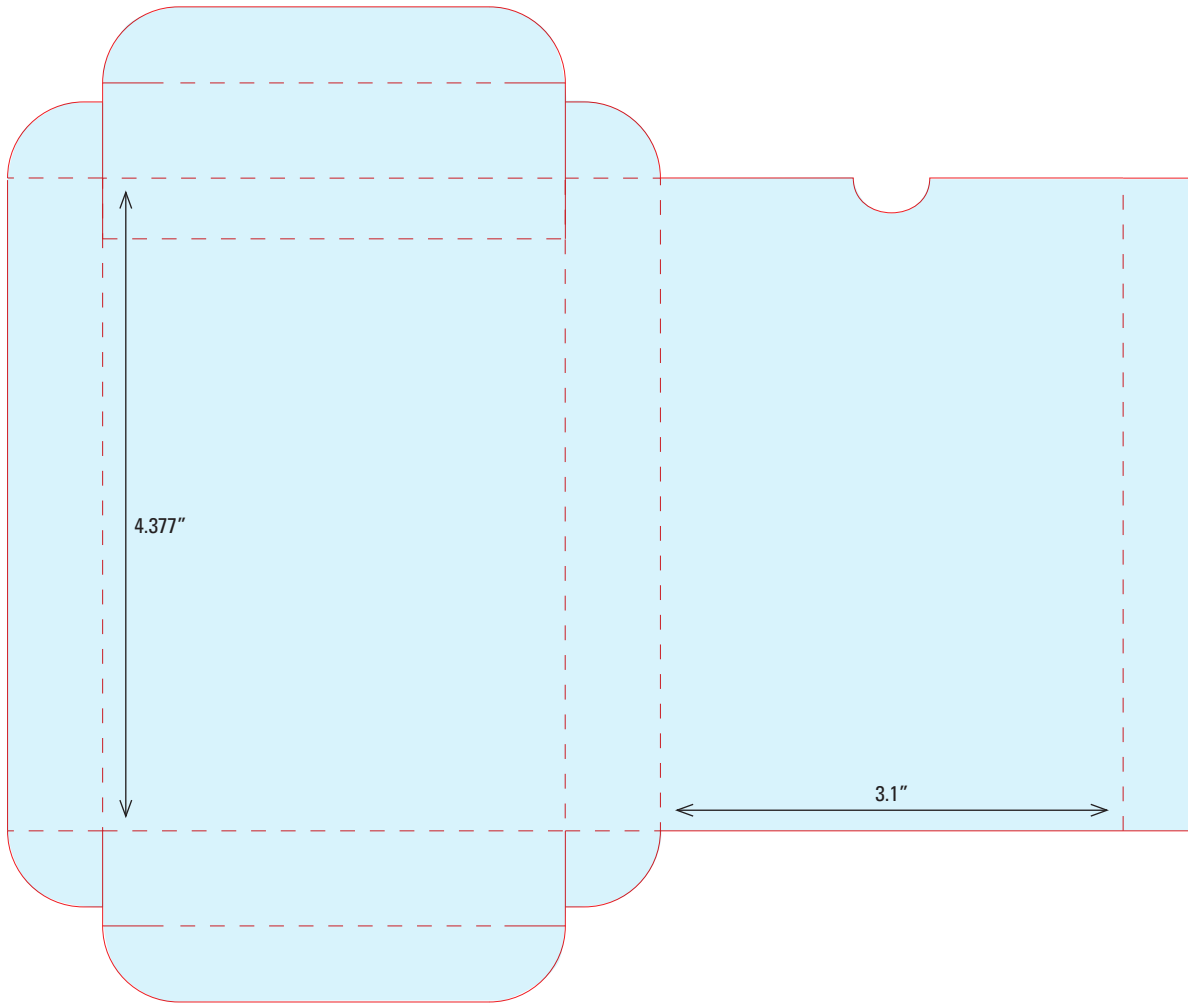

NOT TO SCALE

To order a high res template of a dieline, please contact your sales representative or account manager at 803-796-4000.

DIELINE 61

CD Sleeve

Assembled Size: 5" x 5"

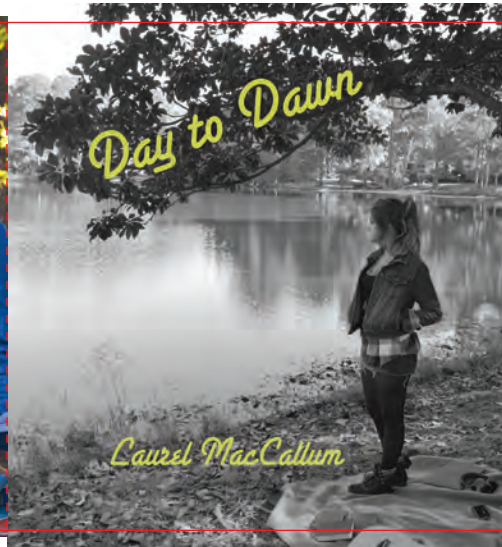
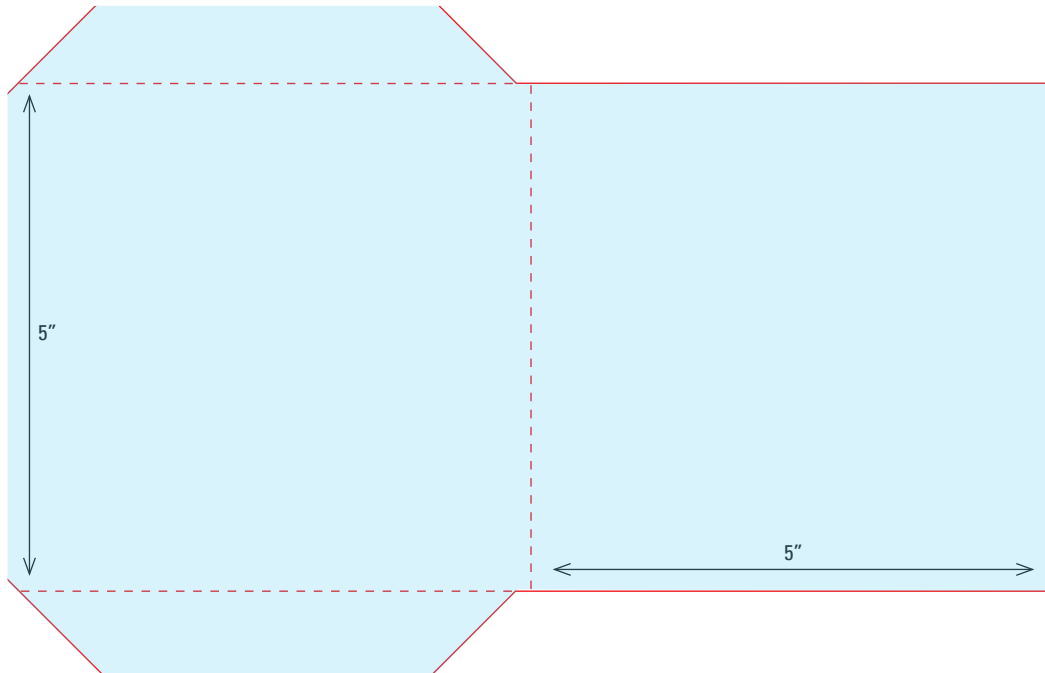

NOT TO SCALE

To order a high res template of a dieline, please contact your sales representative or account manager at 803-796-4000.

DIELINE 62
CD Ecosleeve
Assembled Size: 5" x 5"

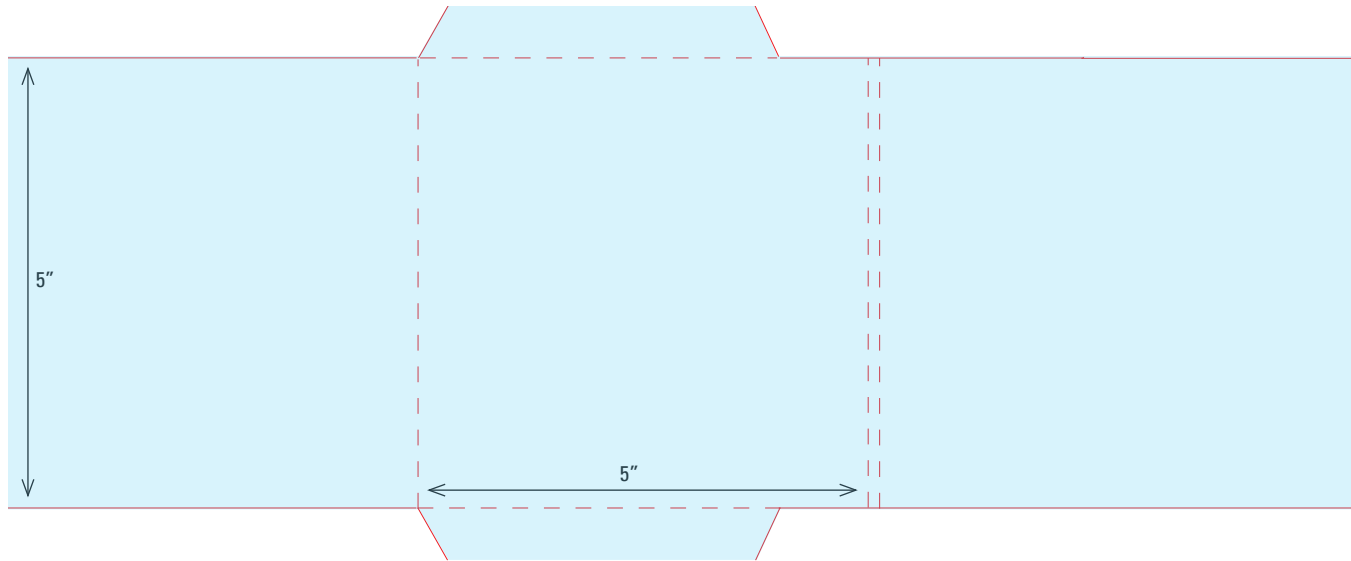

Why hand out the same old *plastic* jewel case with your CDs or DVDs when you can have custom *EcoSleeves*?

Send people a message that your product is different and friendlier to the environment than traditional packaging. And for the full Green Effect, choose an FSC-certified paper like this one.

Ideal for:

- Software developers
- Churches
- Independent music labels
- Media production companies
- Interactive advertising
- Sale presentations



PO Box 5287 • West Columbia, SC 29171 • 1730 Old Dunbar Rd. [29172]
803.796.4000 • 800.948.1074 • Fax 803.796.4527
www.ProPrinters.com

Why just hand them a disk...



NOT TO SCALE

To order a high res template of a dieline,
please contact your sales representative or
account manager at 803-796-4000.

DIELINE 63
CD Cover
Assembled Size: 5" x 5"

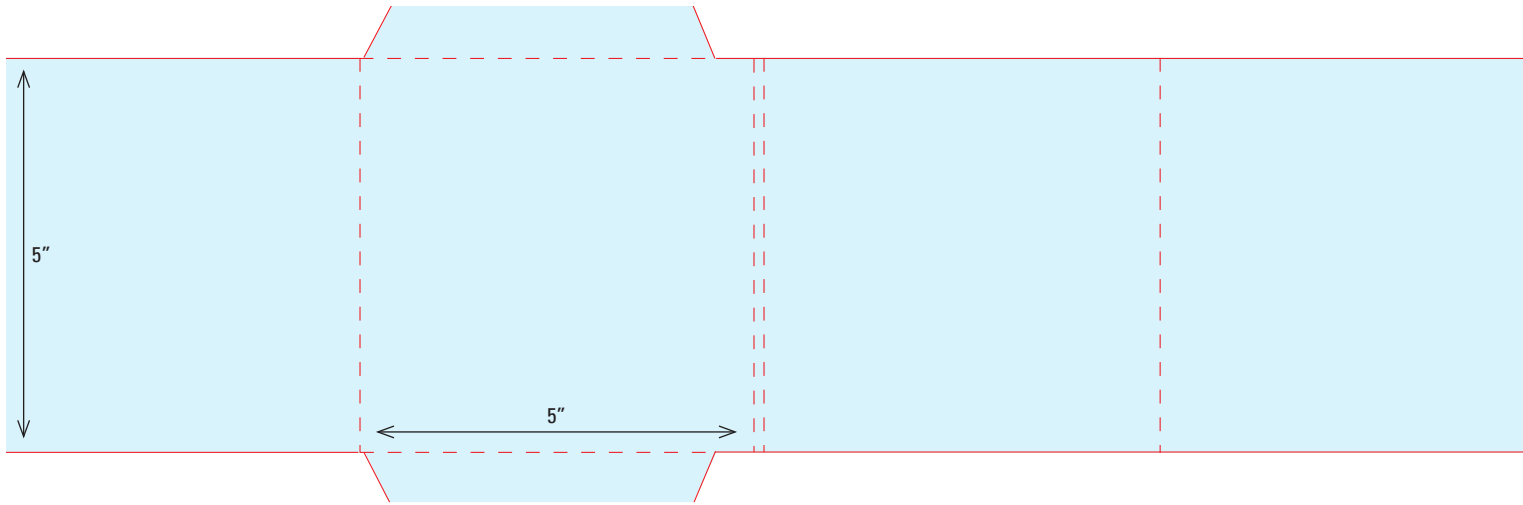

Shine

A new life story of God's faithfulness — a simple message for me — through out my whole life. A message that God is always with me. He never leaves. I will always be here for every, His light and love would shine.

Behind the moon is where Love lives
 It's what I always believed
 On those nights when I'd see it
 Shine... and I... feel special

Inside my room love still visits
 In my window with His light
 He's made sure I always see it
 Shine... so I'd... feel special

As if the moon was there for me
 Lighting my darkness
 No matter where the night
 had gone
 The light would come
 And shine, shine, shine
 Shine, shine, shine on me



*Inside the moon is a message
 At least for me
 Love will always be with me
 So I... feel I... can believe*

As if the moon was just for me
 Lighting my darkness
 No matter how the day had gone
 I can come...



And shine, shine, shine
 Shine, shine, shine on me
 And shine, shine, shine on me
 Shine, shine, shine, shine on me

Behind the moon is where Love lives
 It's what I always believed
 On those nights I look in it
 I believe... and I... feel special
 Shine... shine... shine
 And I shine... so I fall asleep

Ann with Amy Williams
 Anne MacCallum vocal
 Backing vocals: Elvira Lindner
 Jim Howe who plays guitar
 Roger Williams arranger/producer
 Josh Kean drums/percussion



Christ is Born
 We'll Adoration
 Hail My Will
 Lay It On The Altar
 Shine
 So Simple
 Could it Be
 All Your History
 Like Christ
 Your Name
 Love Never Fails
 Strengthen The Hands
 You Are God

S H I N E
 A N N E M A C C A L L U M

"Make Your face shine on Your servant; save me in Your steadfast love." — Psalms 31:16
"The Lord is my light and my salvation, whom shall I fear?" — Psalms 27:1

© 2018 Anne MacCallum. All rights reserved. Unauthorized duplication is violation of applicable laws.
 Product art supported by Kenny McWilliams, Anne MacCallum Studio, Columbia, SC, USA.

These are the super guys and one amazing, fantastic girl who added their creative genius to this project. God's unique creativity coming from each one of them was an amazing thing to watch! What a privilege and honor to have them! Randy R. said it would sell CD. If I made sure to include a picture of Nate. THANKS: Jeremiah, Chad, Gary, Christine, Dan, Kenny, Steven, Josh, Rogge, Neil, Jack and... Nate.

Josh Kean, Kenny McWilliams, and Chad Rochester all appear courtesy of EyeBall Records.

All words and melodies by Anne MacCallum except Gospels (of course) and Love Heart Faith by Anne MacCallum and Jeremiah Jones. All music arrangements by each song. Project arrangements by Kenny McWilliams and Anne MacCallum. Recorded at Archer Avenue Studios in Columbia, SC, USA. Additional recording at Hubs Studios, CD and Madison Studios, Columbia, SC, USA.

Art Director: Anne MacCallum. Graphics: Josh MacCallum. Photography: Anne MacCallum, Cher Sheldon, and Mark McLane.

Thanks to all the great musicians who have played with me over the years. I am grateful for the blessing of collaboration with the Body of Christ.

Produced and engineered by Kenny McWilliams.
Additional engineering by Eric McCoy.
Mixed & mastered by Greg Davis at Jazz Team Studios, Germany, with Markus Greisler, Jazz Team Tst Engineer.

I want to be made in every season to speak of the things I have seen while teaching The King. I have seen His power for His people. I have witnessed His... I am also privileged to share the words He has used to communicate with His Team just for listening.

My heart is lighting a good matter. I speak of the things which I have made teaching The King my tongue in the pen of a ready writer. —Psalms 45:1

NOT TO SCALE

To order a high res template of a dieline, please contact your sales representative or account manager at 803-796-4000.

DIELINE 64

Hang Tag w/ BC Slits
and 2 Scores for Folding
Finished Size: 3.75" x 13.5"

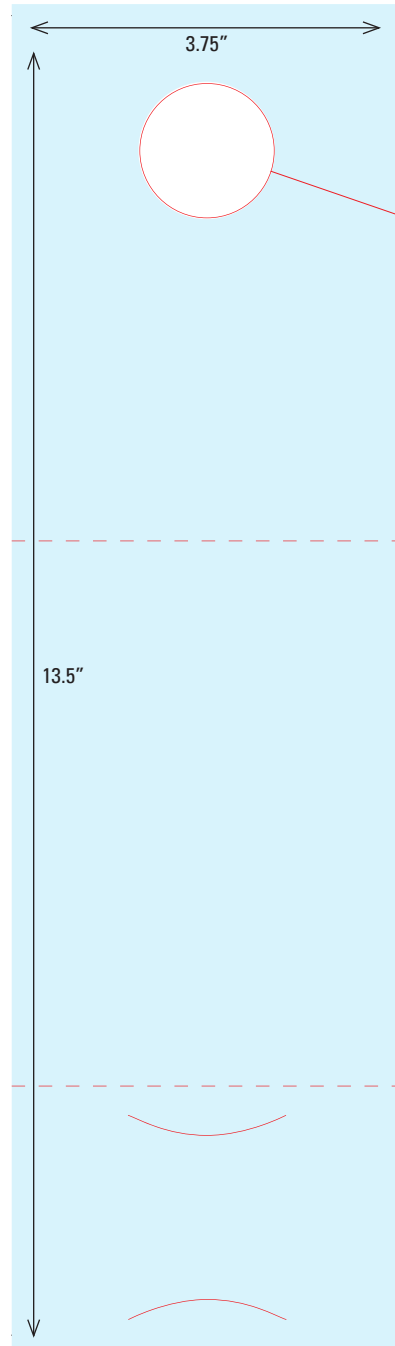

NOT TO SCALE

To order a high res template of a dieline,
please contact your sales representative or
account manager at 803-796-4000.

DIELINE 65

Hang Tag w/ BC Slits and
Perf for Removal
Finished Size: 4" x 10.5"

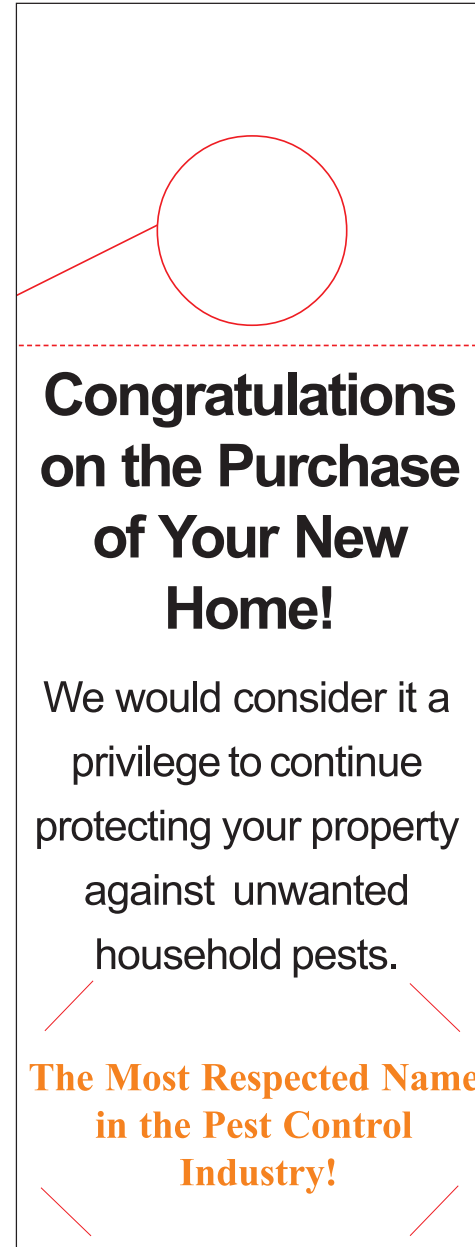
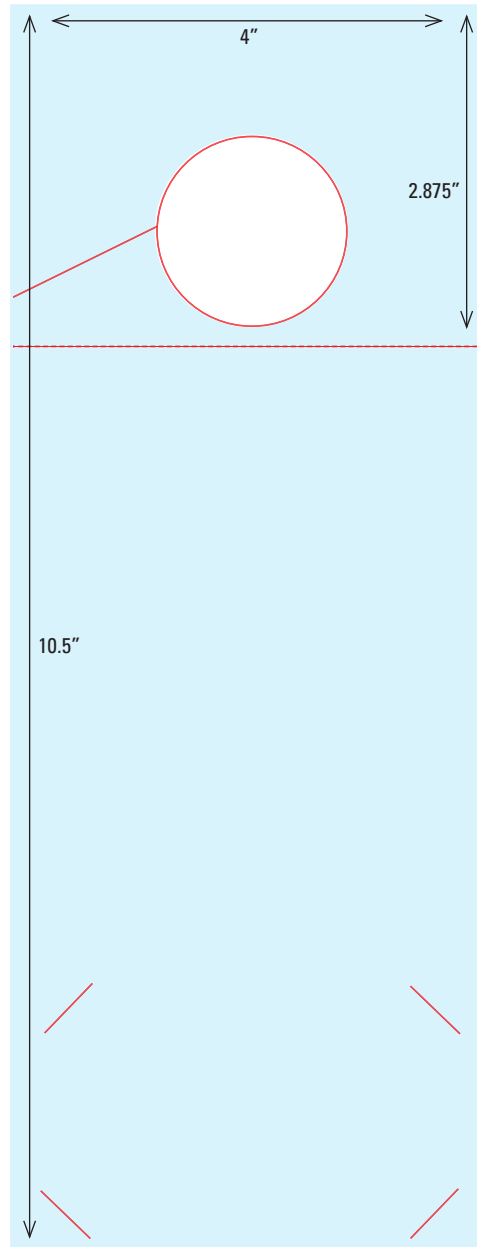

NOT TO SCALE

To order a high res template of a dieline,
please contact your sales representative or
account manager at 803-796-4000.

DIELINE 66

Hang Tag

Finished Size: 4" x 10.4"

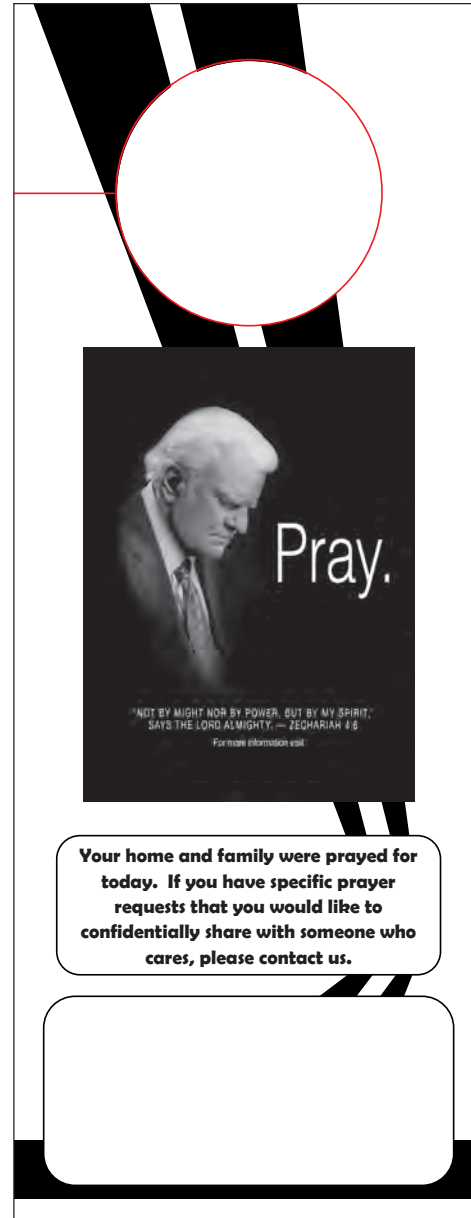
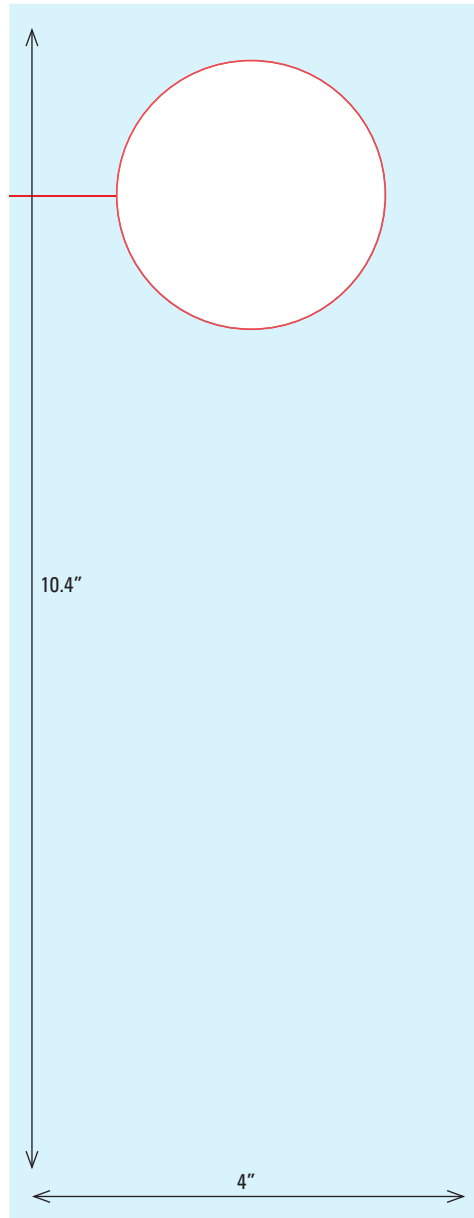

NOT TO SCALE

To order a high res template of a dieline, please contact your sales representative or account manager at 803-796-4000.

DIELINE 67

Hang Tag

Finished Size: 4.25" x 11"

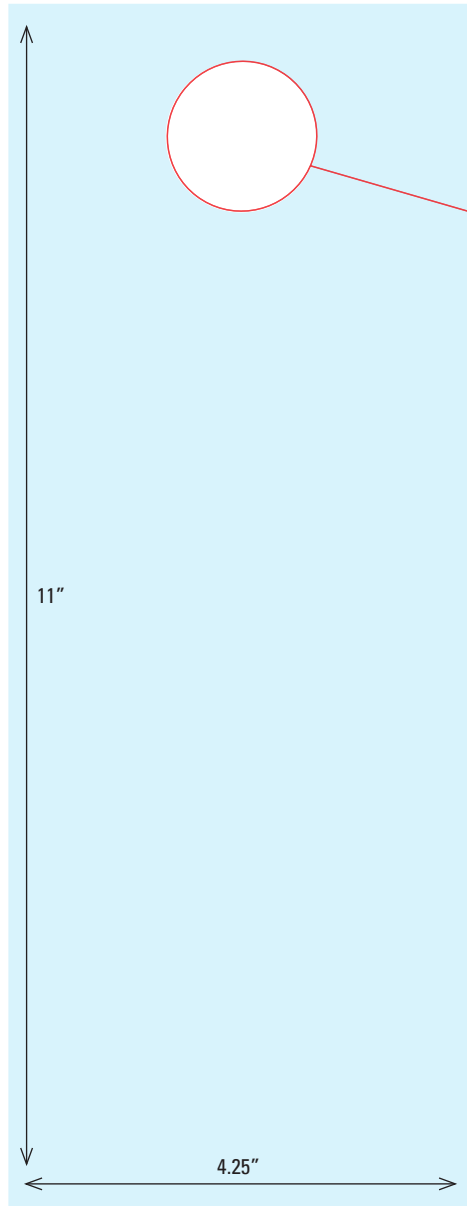

NOT TO SCALE

To order a high res template of a dieline, please contact your sales representative or account manager at 803-796-4000.

DIELINE 68

Hang Tag w/Score and Perf
Finished Size: 5" x 16"

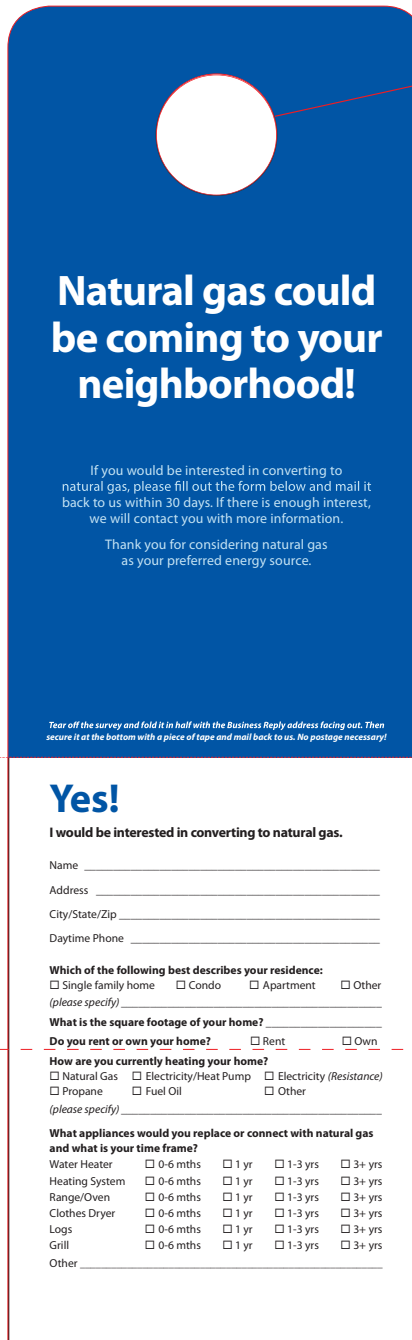
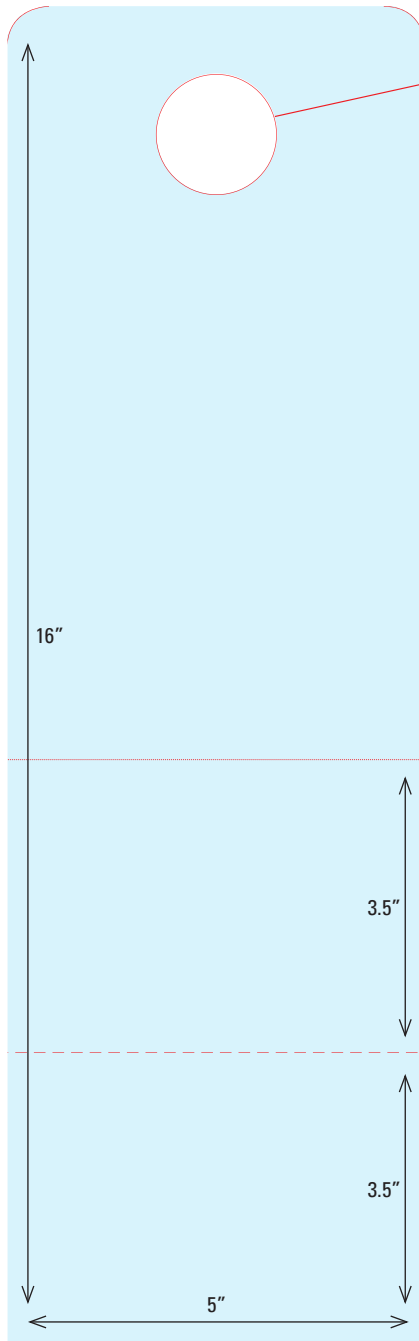

Natural gas could be coming to your neighborhood!

If you would be interested in converting to natural gas, please fill out the form below and mail it back to us within 30 days. If there is enough interest, we will contact you with more information.

Thank you for considering natural gas as your preferred energy source.

Tear off the survey and fold it in half with the Business Reply address facing out. Then secure it at the bottom with a piece of tape and mail back to us. No postage necessary!

Yes!

I would be interested in converting to natural gas.

Name _____

Address _____

City/State/Zip _____

Daytime Phone _____

Which of the following best describes your residence:

Single family home Condo Apartment Other
(please specify) _____

What is the square footage of your home? _____

Do you rent or own your home? Rent Own

How are you currently heating your home?

Natural Gas Electricity/Heat Pump Electricity (Resistance)
 Propane Fuel Oil Other
(please specify) _____

What appliances would you replace or connect with natural gas and what is your time frame?

Water Heater 0-6 mths 1 yr 1-3 yrs 3+ yrs
Heating System 0-6 mths 1 yr 1-3 yrs 3+ yrs
Range/Oven 0-6 mths 1 yr 1-3 yrs 3+ yrs
Clothes Dryer 0-6 mths 1 yr 1-3 yrs 3+ yrs
Logs 0-6 mths 1 yr 1-3 yrs 3+ yrs
Grill 0-6 mths 1 yr 1-3 yrs 3+ yrs
Other _____

NOT TO SCALE

To order a high res template of a dieline, please contact your sales representative or account manager at 803-796-4000.

DIELINE 69

Hang Tag

Finished Size: 4.5" x 12"

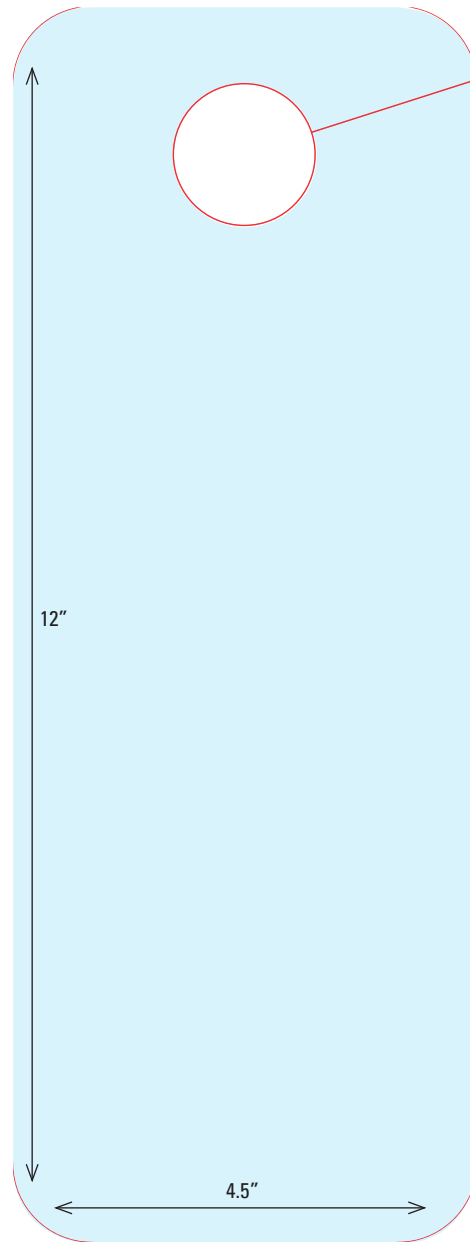

NOT TO SCALE

To order a high res template of a dieline, please contact your sales representative or account manager at 803-796-4000.

DIELINE 70

Hang Tag w/Perfs

Finished Size: 4.5" x 14"

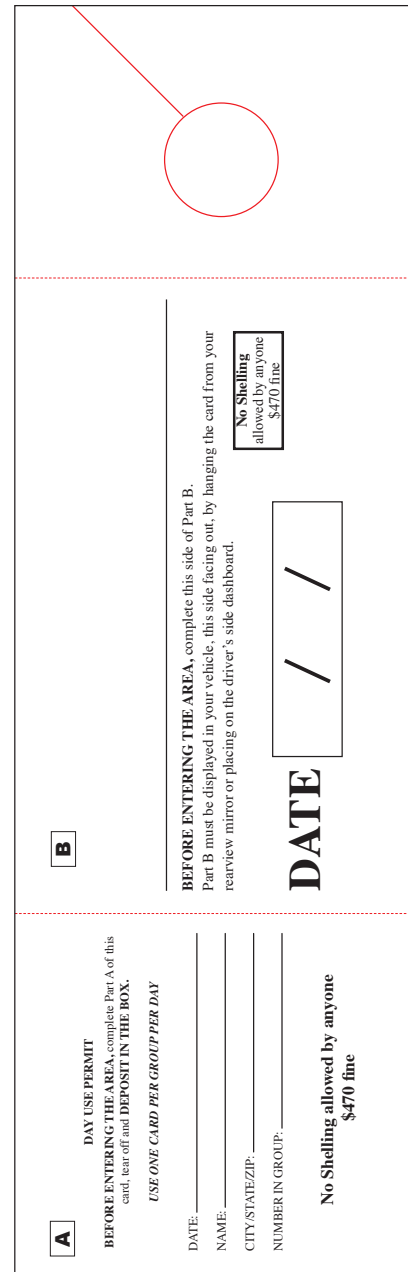
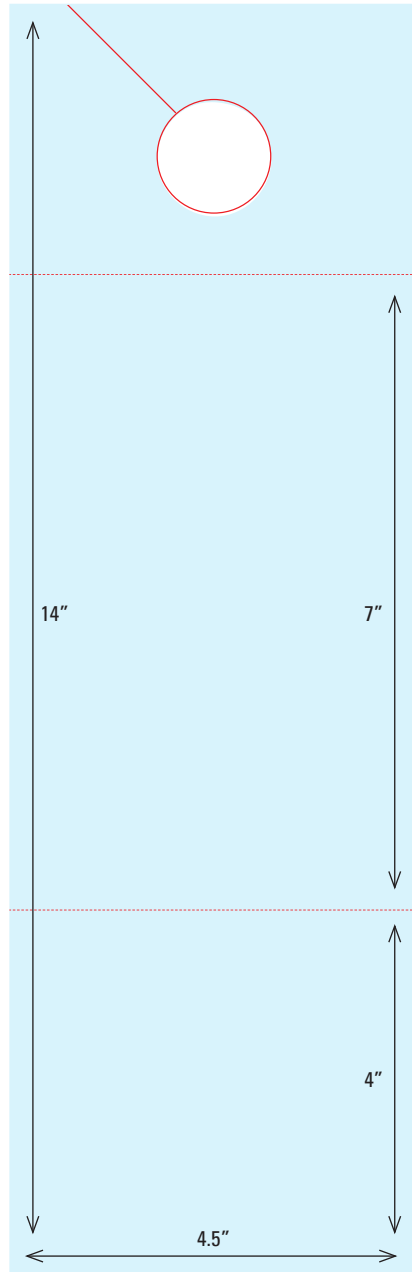

NOT TO SCALE

To order a high res template of a dieline, please contact your sales representative or account manager at 803-796-4000.

DIELINE 71
Hang Tag
Finished Size: 3.5" x 9.25"

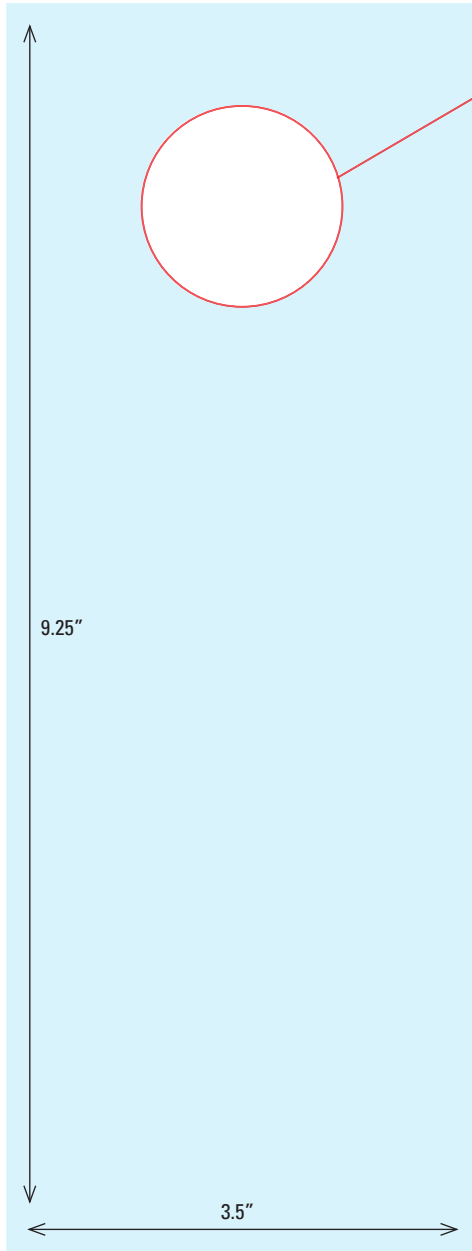

NOT TO SCALE

To order a high res template of a dieline,
please contact your sales representative or
account manager at 803-796-4000.

DIELINE 72
Hang Tag
Finished Size: 3.25" x 8"

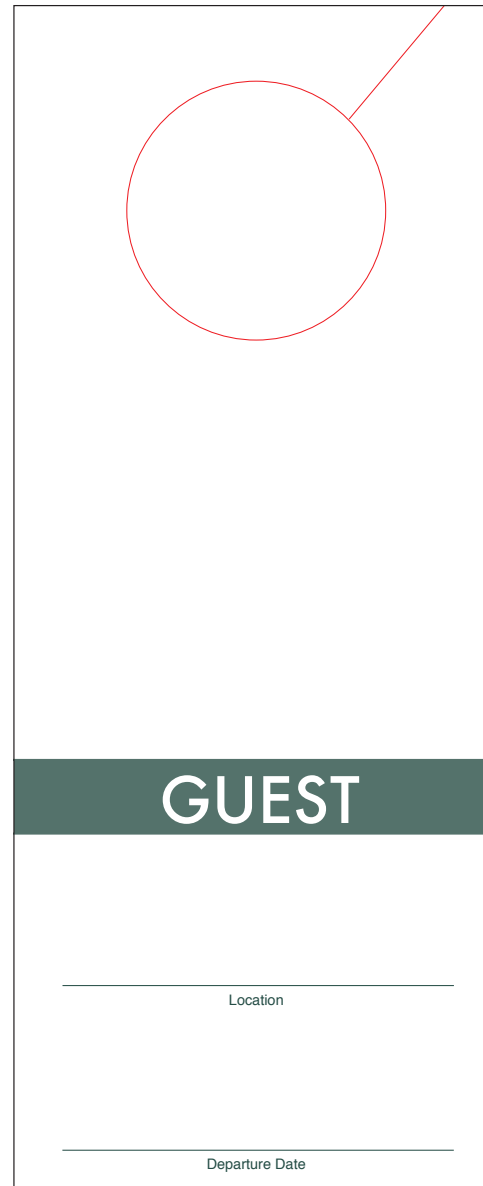
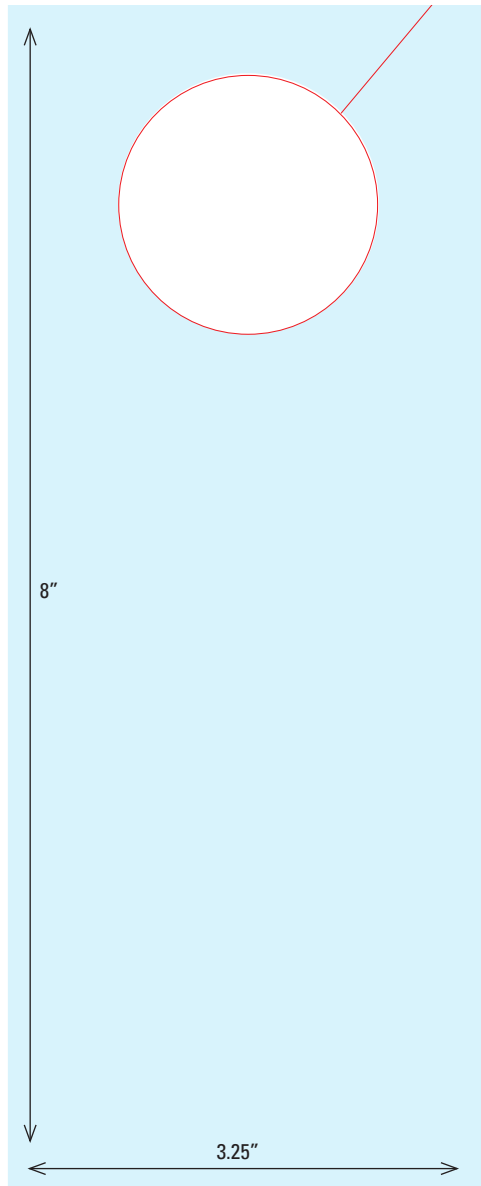

NOT TO SCALE

To order a high res template of a dieline,
please contact your sales representative or
account manager at 803-796-4000.

DIELINE 73
Hang Tag
Finished Size: 3.5" x 7"

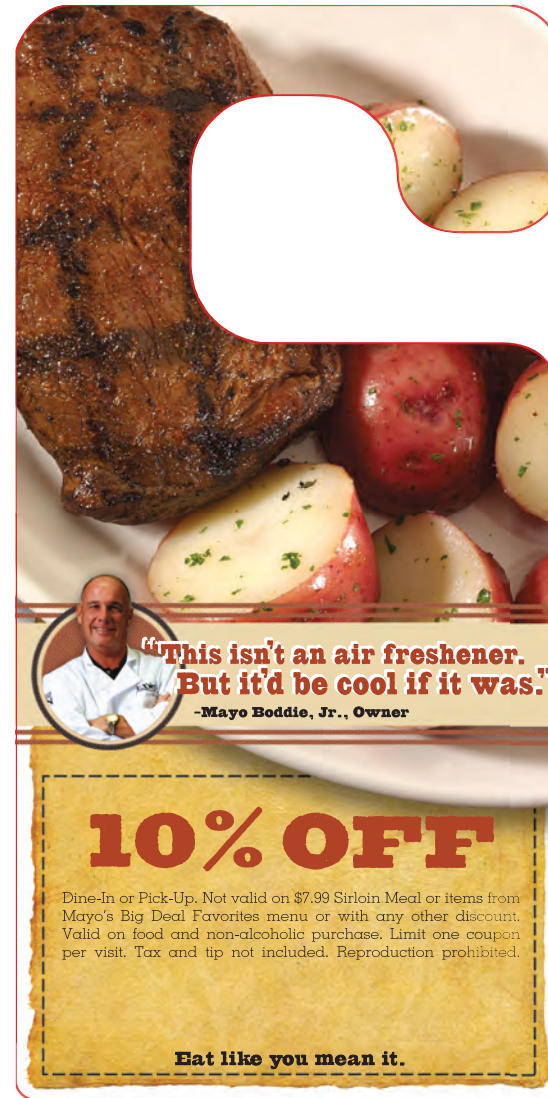
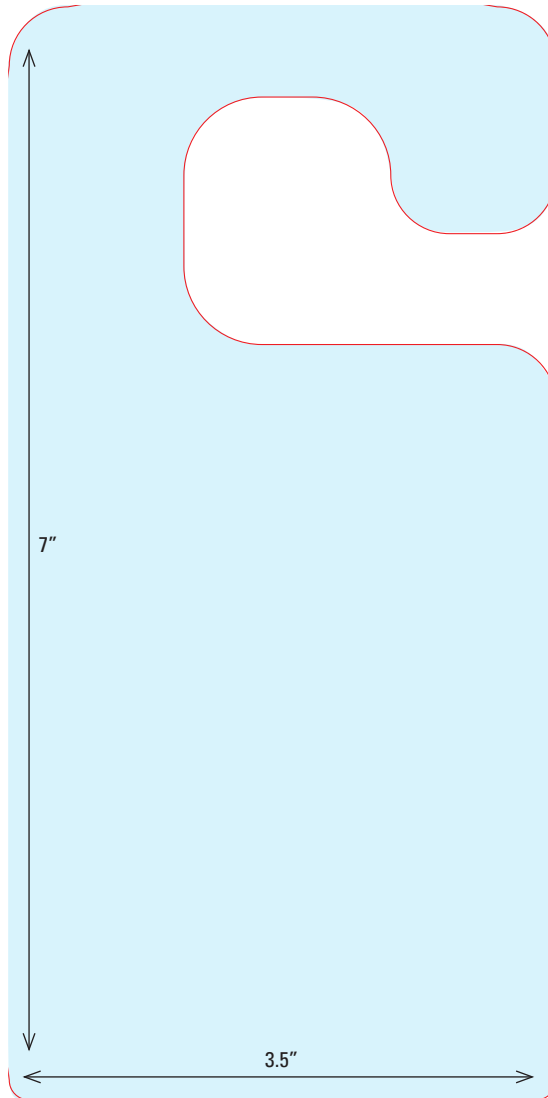

NOT TO SCALE

To order a high res template of a dieline, please contact your sales representative or account manager at 803-796-4000.

DIELINE 74

Circle

Finished Size: 2.5" diameter

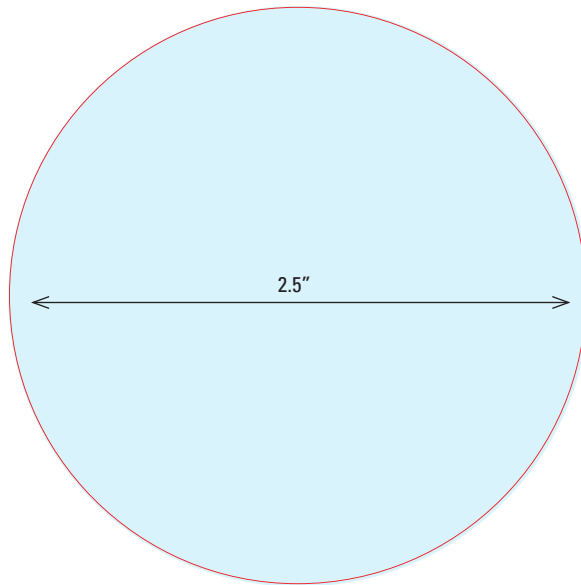

NOT TO SCALE

To order a high res template of a dieline,
please contact your sales representative or
account manager at 803-796-4000.

DIELINE 75

Circle

Finished Size: 4" diameter

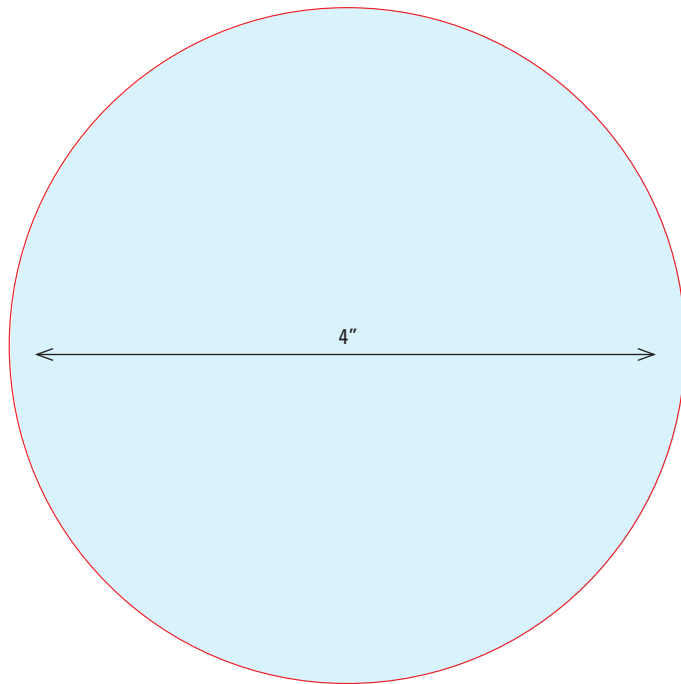

NOT TO SCALE

To order a high res template of a dieline,
please contact your sales representative or
account manager at 803-796-4000.

DIELINE 76

Oval

Finished Size: 5.0625" x 3.0625"

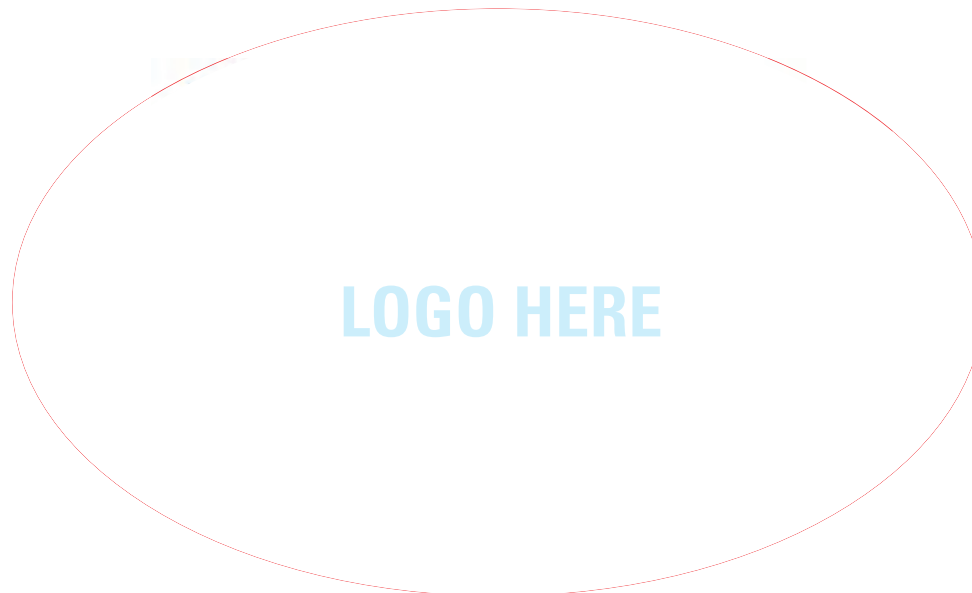
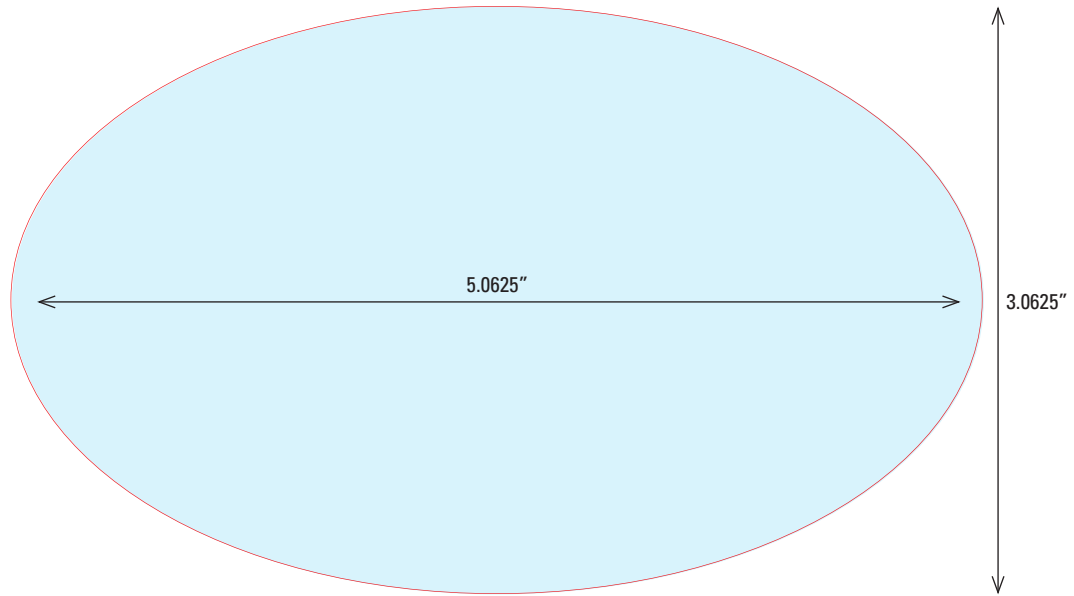

NOT TO SCALE

To order a high res template of a dieline,
please contact your sales representative or
account manager at 803-796-4000.

DIELINE 77

Oval

Finished Size: 3" x 2" oval

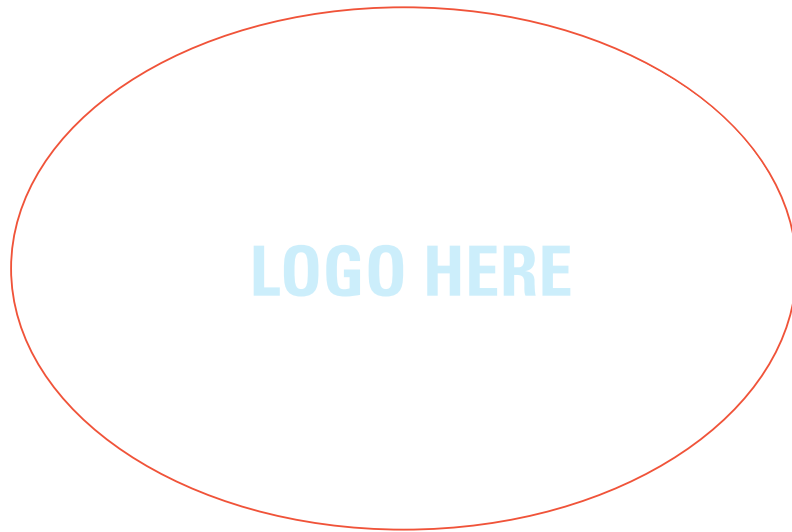
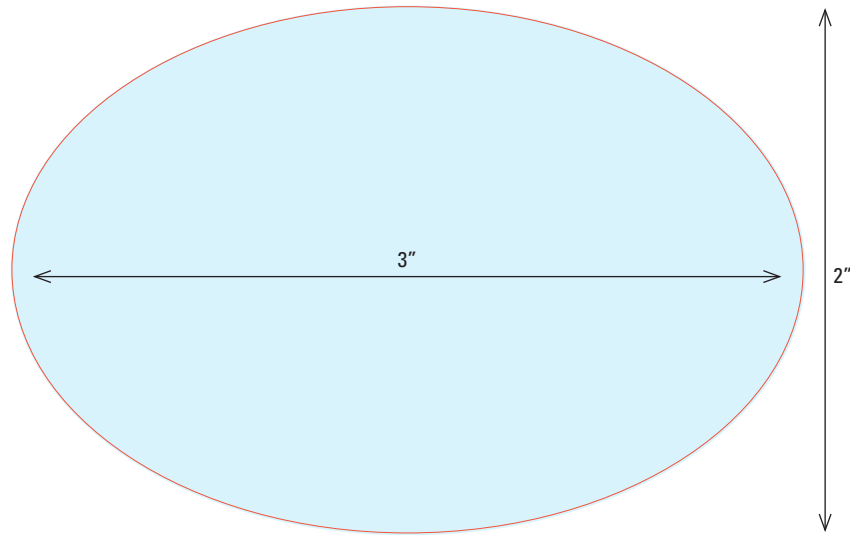

NOT TO SCALE

To order a high res template of a dieline,
please contact your sales representative or
account manager at 803-796-4000.

DIELINE 78

Pocket Folder w/BC Slits

Horizontal Pocket

Finished Size: 9.5" x 12"

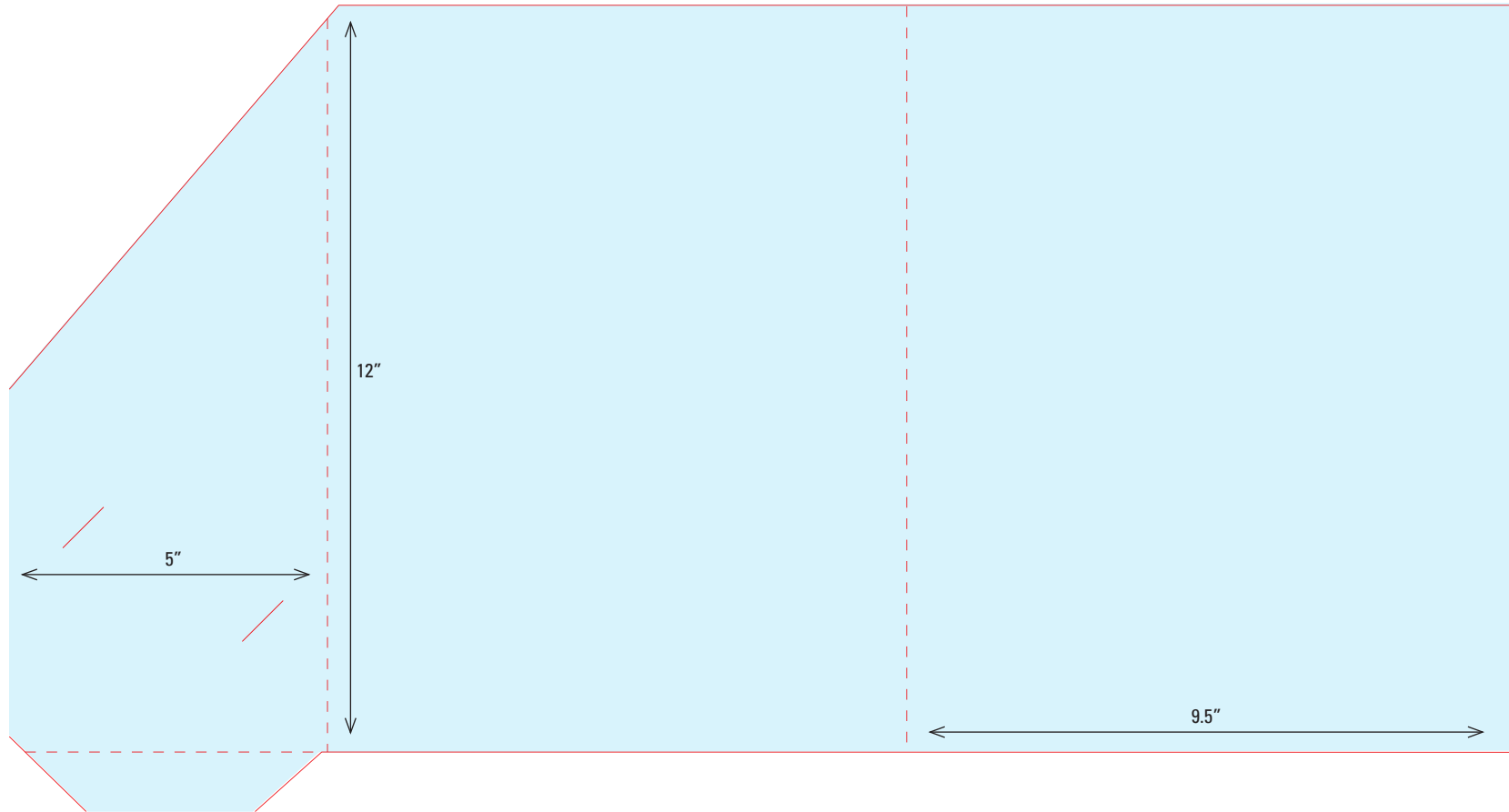

NOT TO SCALE

To order a high res template of a dieline,
please contact your sales representative or
account manager at 803-796-4000.

DIELINE 79

Small Pocket Folder
Finished Size: 4.5" x 8"

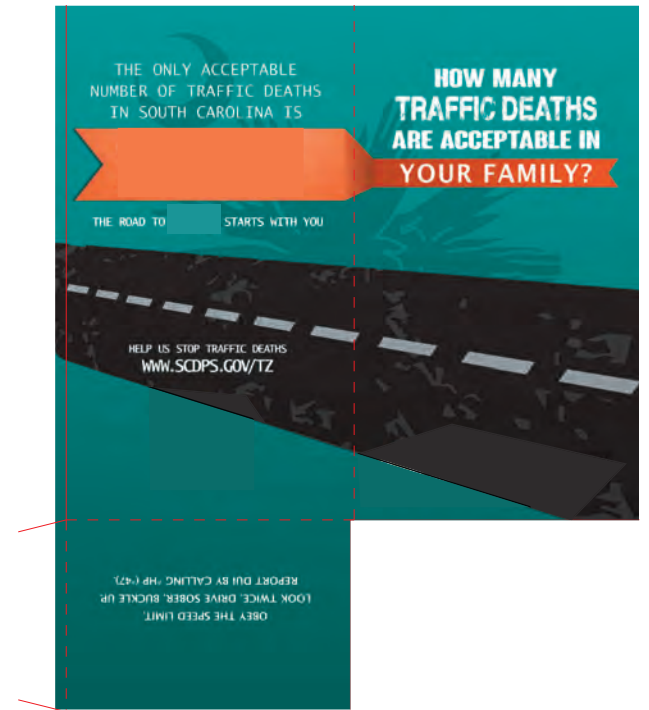
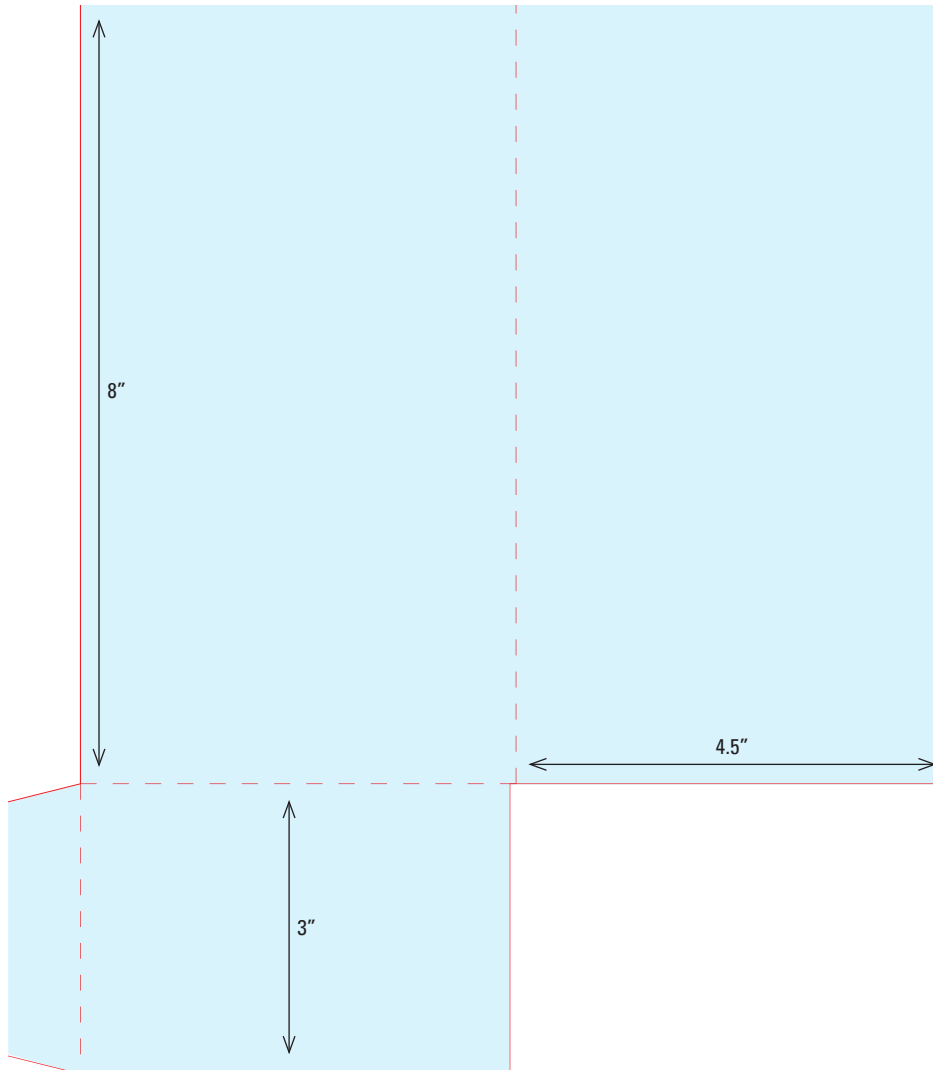

NOT TO SCALE

To order a high res template of a dieline,
please contact your sales representative or
account manager at 803-796-4000.

DIELINE 80

Pocket Folder w/ 8.5" Pocket

Finished Size: 9" x 12"

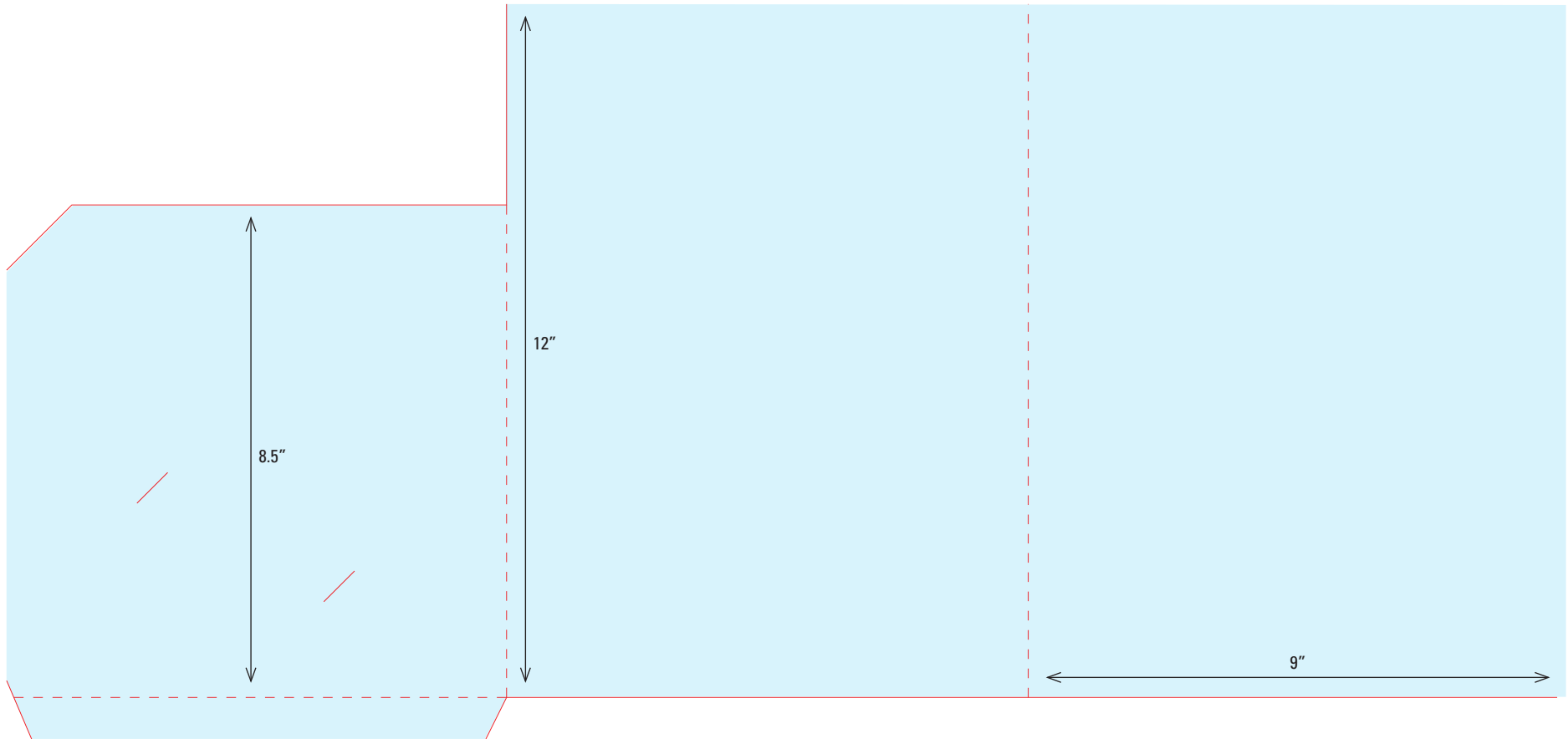

NOT TO SCALE

To order a high res template of a dieline,
please contact your sales representative or
account manager at 803-796-4000.

DIELINE 81

Magazine Cover,
Landscape w/ 4.75" Pocket
Finished Size: 8" x 5"



NOT TO SCALE

To order a high res template of a dieline,
please contact your sales representative or
account manager at 803-796-4000.

DIELINE 82

Rack Card Pocket Folder
Finished Size: 4.25" x 9.5"

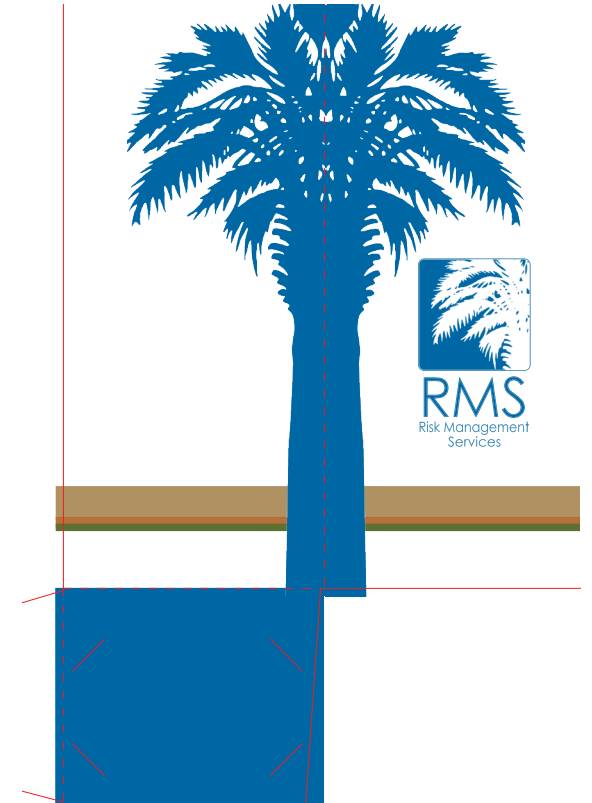
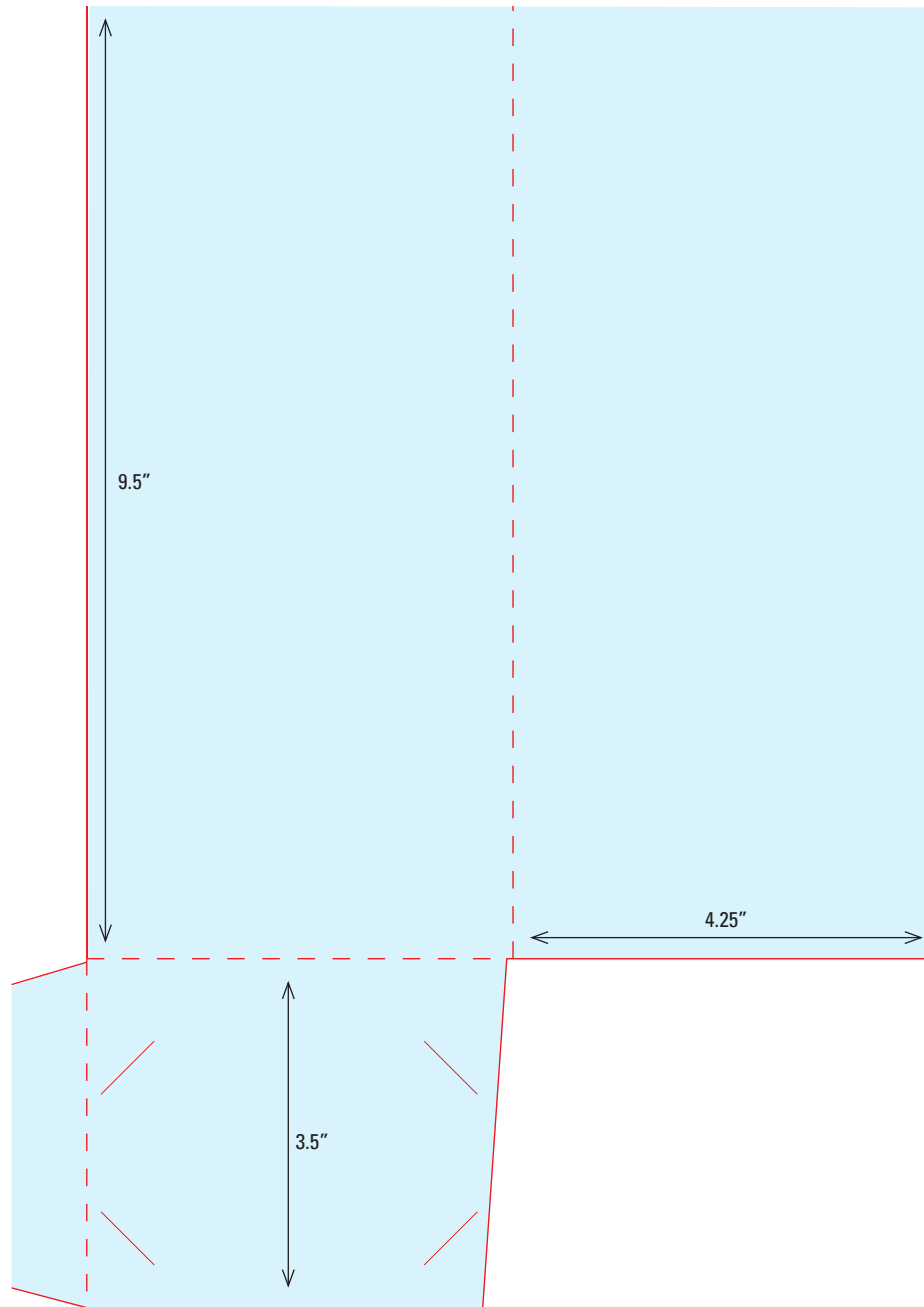

NOT TO SCALE

To order a high res template of a dieline,
please contact your sales representative or
account manager at 803-796-4000.

DIELINE 83

Square Pocket Folder
Finished Size: 8.5" x 8.5"

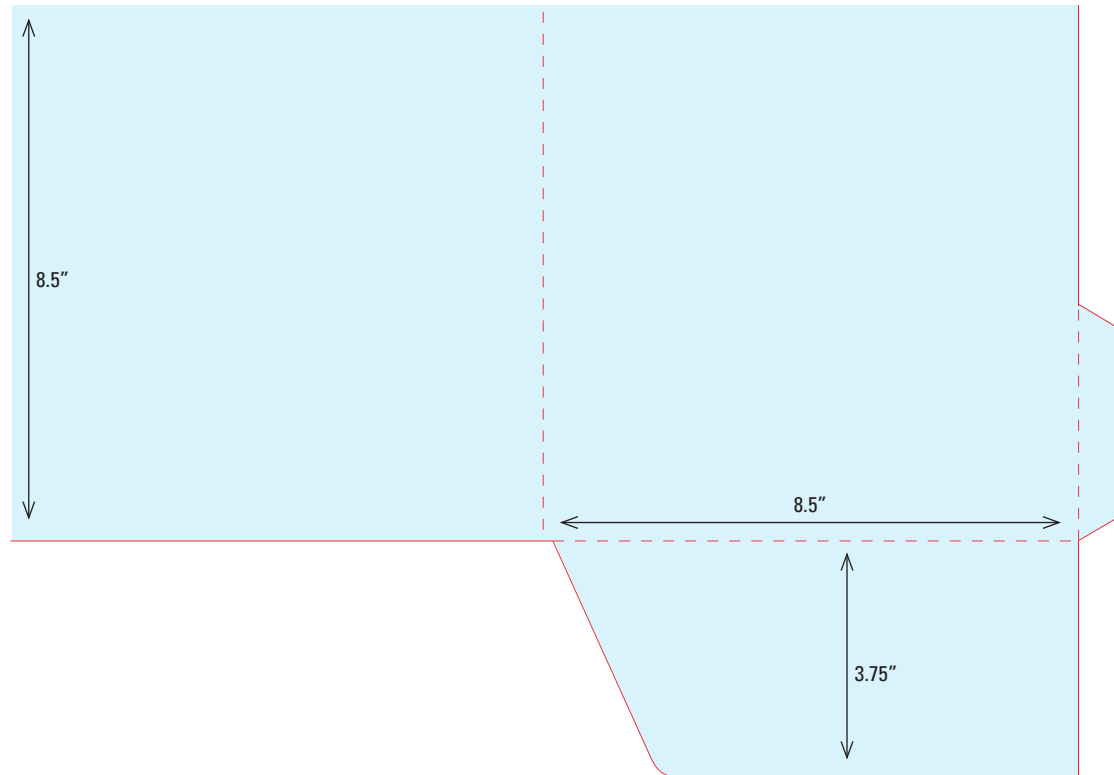

NOT TO SCALE

To order a high res template of a dieline, please contact your sales representative or account manager at 803-796-4000.

DIELINE 84

Pocket Folder

Finished Size: 4" x 10"

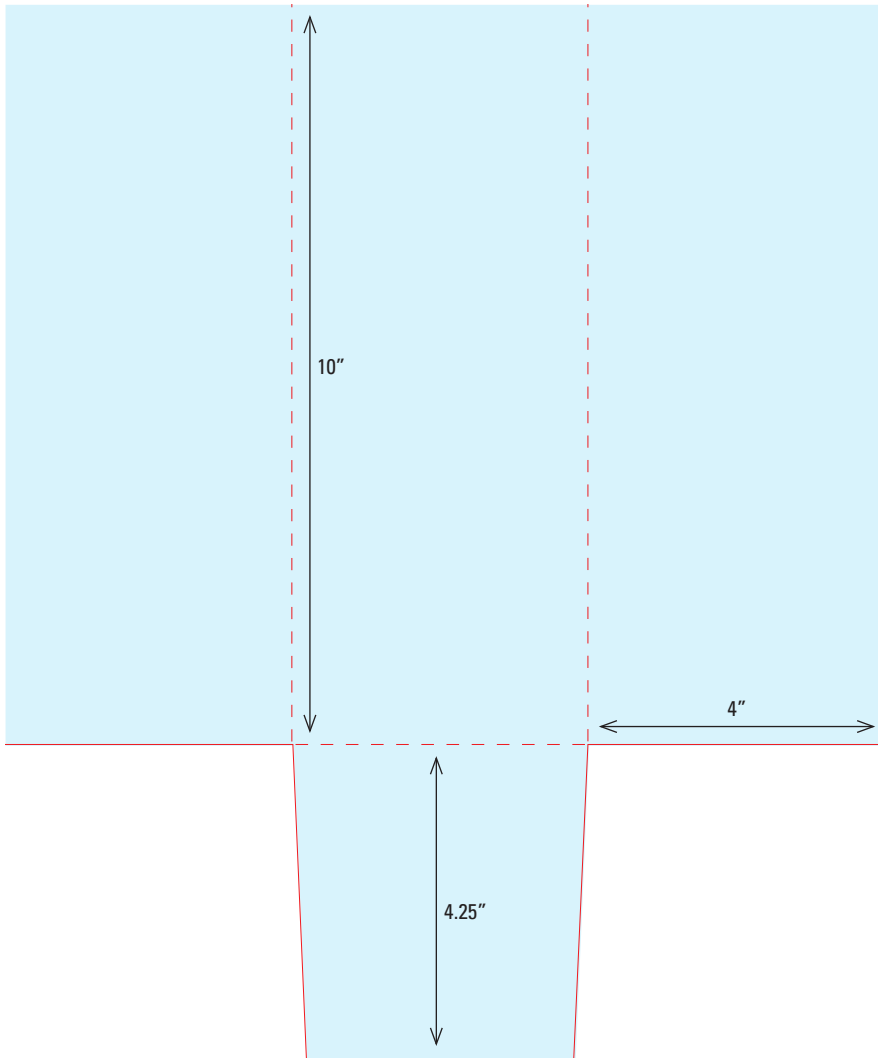

NOT TO SCALE

To order a high res template of a dieline, please contact your sales representative or account manager at 803-796-4000.

DIELINE 85

Pocket Folder

2 Horizontal Slits for Inserts

Finished Size: 4.25" x 10.125"

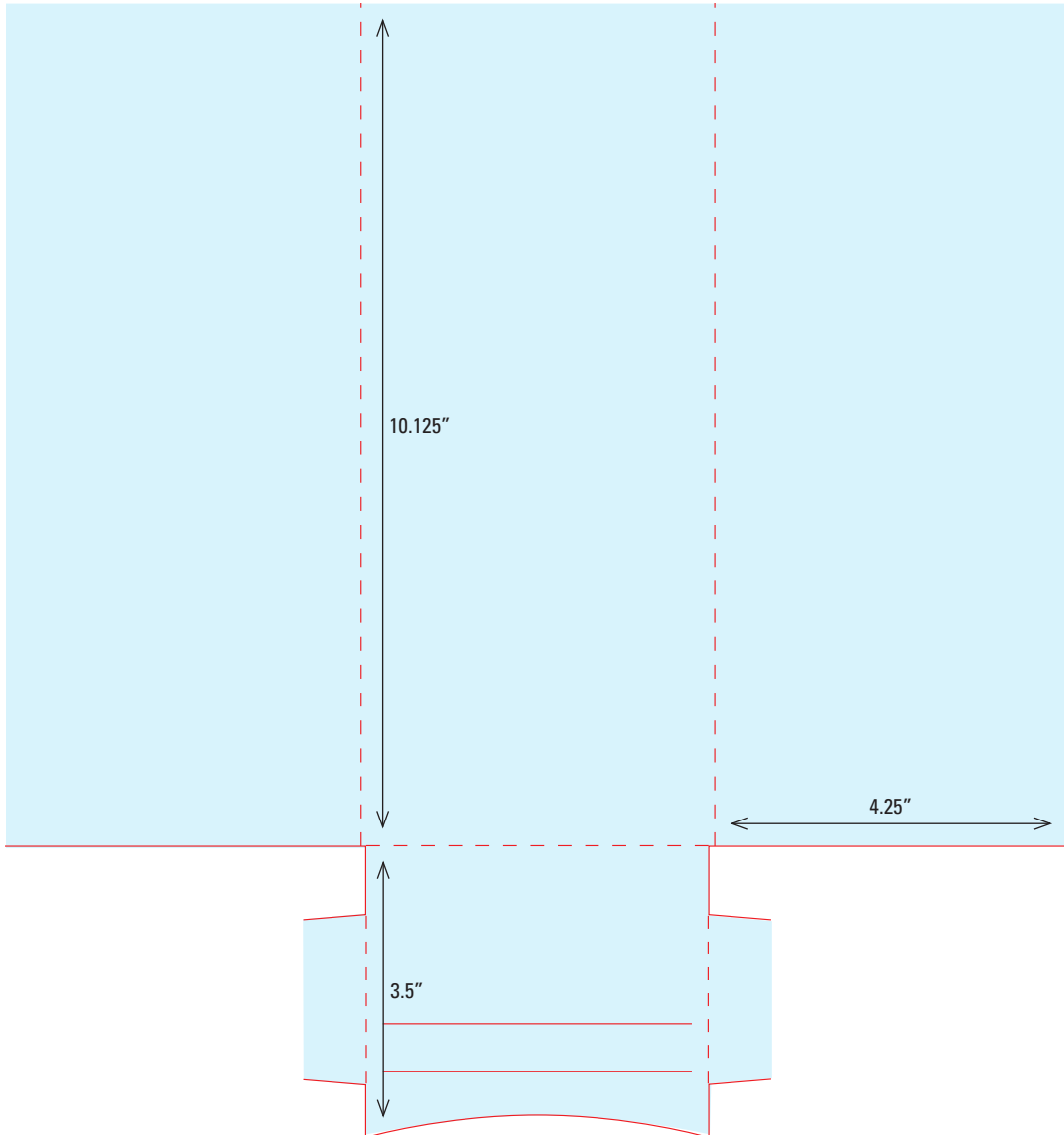

NOT TO SCALE

To order a high res template of a dieline,
please contact your sales representative or
account manager at 803-796-4000.

DIELINE 86

Label Sheet
w/2 Kiss Cuts for Removal
Finished Size: 2" x 3"
Kiss Cut Size: 0.4375" x 0.5"

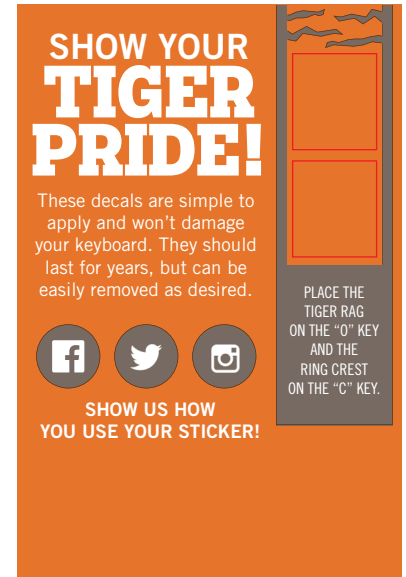
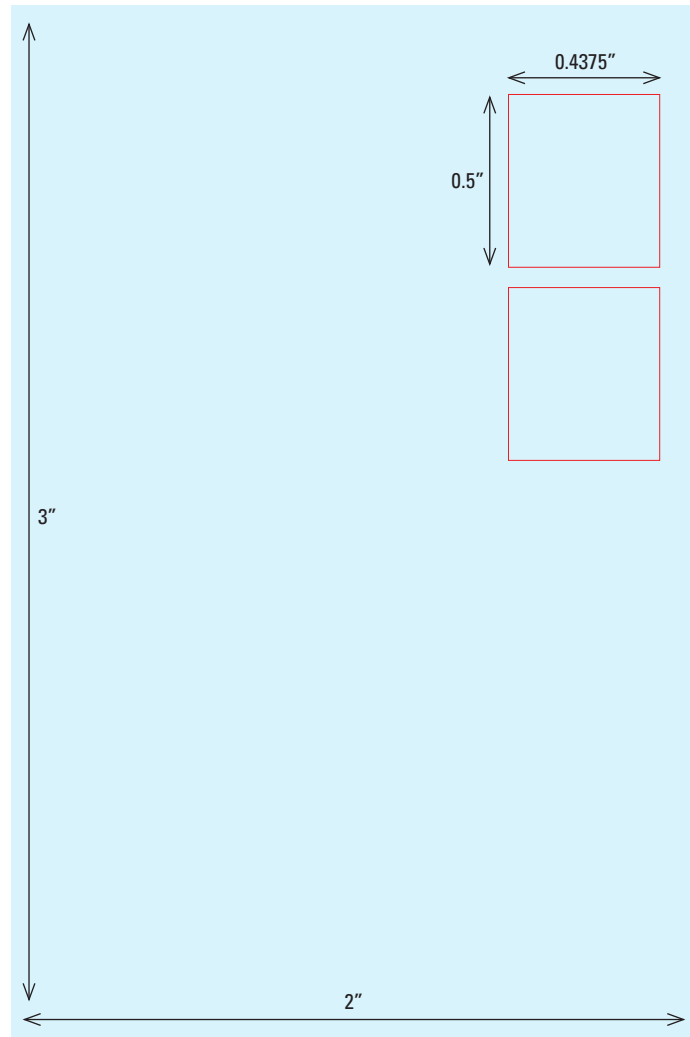

NOT TO SCALE

To order a high res template of a dieline,
please contact your sales representative or
account manager at 803-796-4000.

DIELINE 87
 Brochure with BC Slits
 Finished Size: 5.5" x 8.5"

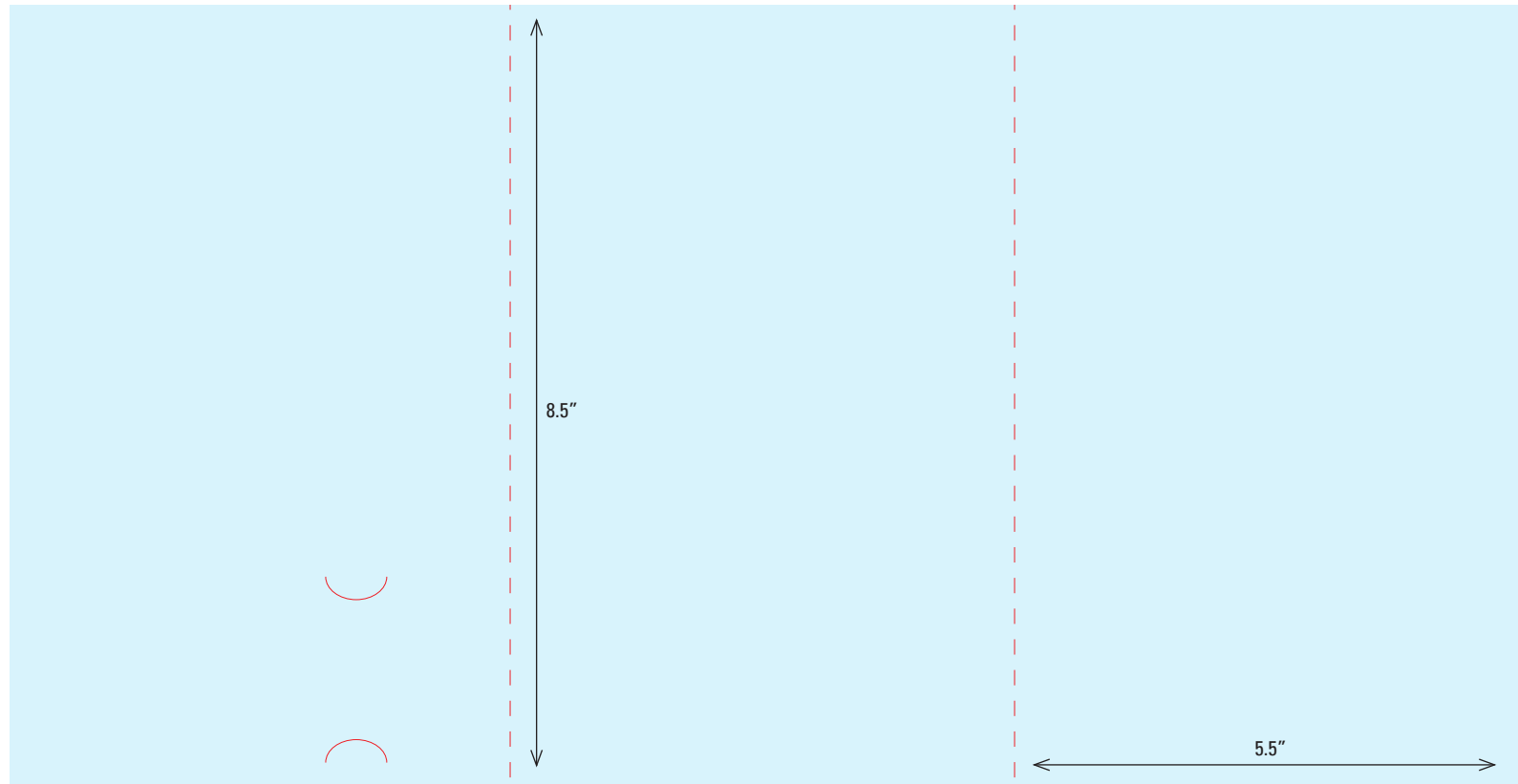

Call today to schedule a visit and learn more about retirement living at SCBMA – Retirement living in a family atmosphere.

We want to help as you explore this important decision and change.

Our residents come here to LIVE!

- Dining options
- Wi-Fi
- Cable TV
- Garage
- 24/7 emergency call system
- Scheduled transportation
- Barber/Beauty services
- Activities for the mind, body and spirit
- Cultural, social, educational and recreational events

The joy of community living is fellowship and camaraderie found by sharing meals, activities and life experiences. Our life-enrichment coordinators plan activities to maintain a healthy lifestyle socially, physically and spiritually.

- Fitness center
- Walking/golf cart paths
- Labs stocked with fish
- Library
- Housekeeping services
- Regular hospice services
- Landscaping and maintenance
- Indoor pool (beach only)

Two communities
 One mission

8-15 | 1000

G47
 PPI 116857

NOT TO SCALE
 To order a high res template of a dieline, please contact your sales representative or account manager at 803-796-4000.

DIELINE 88
Pocket Folder
Finished Size: 8.75" x 5.625"

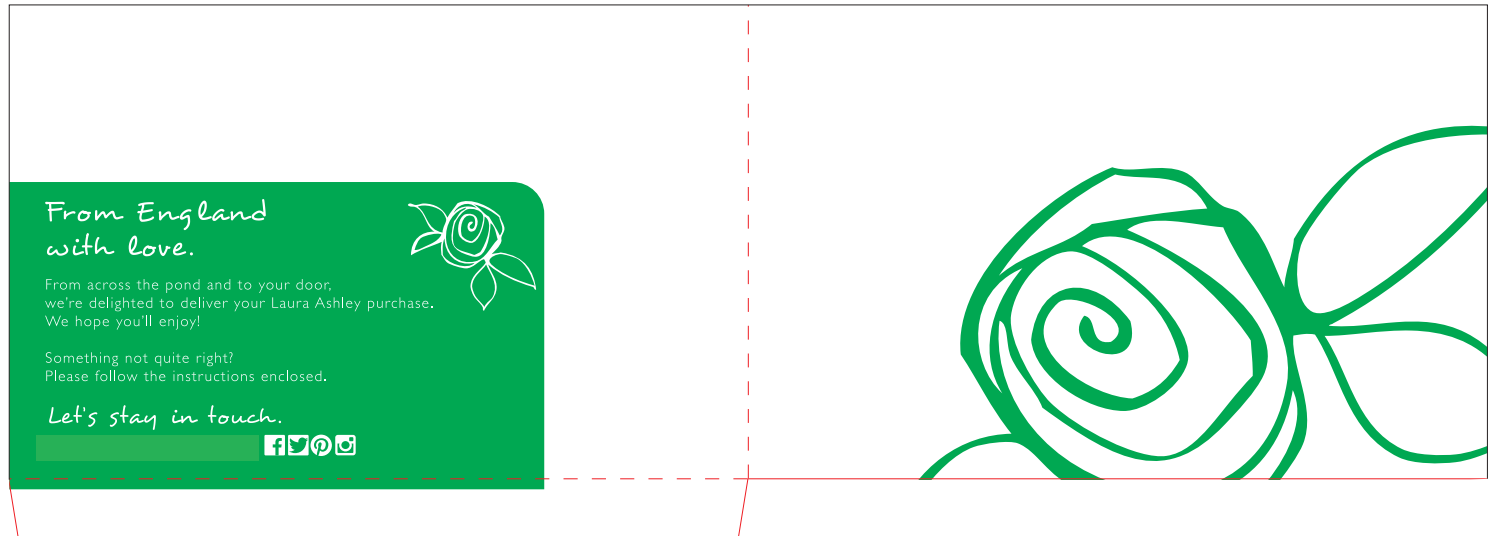
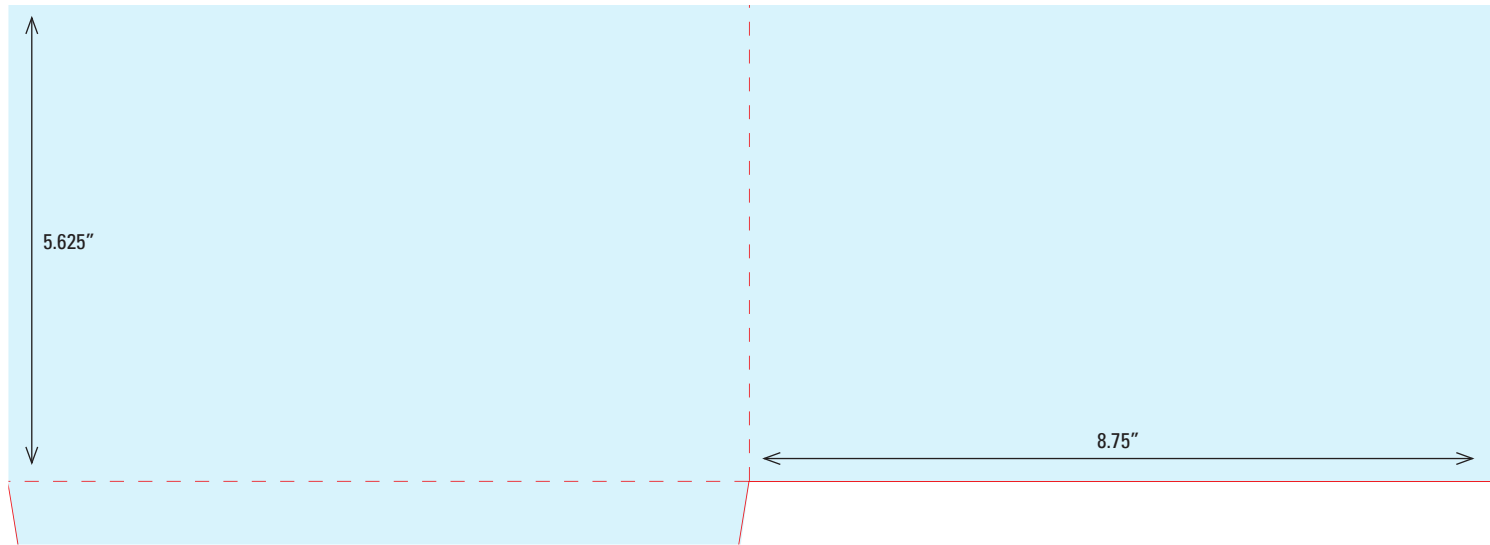

NOT TO SCALE

To order a high res template of a dieline,
please contact your sales representative or
account manager at 803-796-4000.

